

TYPICAL THRUST BLOCK  
Scale: 1/8" = 1'-0"

THRUST BLOCK SCHEDULE

NO.	STATION	D	L	T	U	W	HORIZ. STEEL (VERT. STEEL)
1	2+10	3.5'	7.0'	3.0'	-	2.0'	3" x 4" x 10' C
2	6+10	3.0'	11.0'	5.0'	-	5.4'	3" x 4" x 10' C
3	10+30	3.0'	7.0'	4.0'	-	3.0'	3" x 4" x 10' C
4	11+33.6	3.0'	8.5'	4.0'	-	3.4'	3" x 4" x 10' C
5	14+03.6	2.0'	3.5'	2.5'	-	0.6'	2" x 4" x 10' C
6	21+33.4 & 21+34.4	3.0'	12.0'	5.0'	-	6.4'	3" x 4" x 10' C
7	23+54.4 & 23+55.4	3.5'	16.5'	4.0'	-	6.5'	3" x 4" x 10' C
8	27+14.0	2.0'	20.0'	5.0'	-	12.7'	1 1/2" x 6" x 5' x 10' C
9	32+8.3	2.0'	18.0'	4.0'	-	12.7'	1 1/2" x 6" x 5' x 10' C
10	137+58.4	2.0'	16.0'	5.0'	-	12.7'	1 1/2" x 6" x 5' x 10' C
11	143+31.2	2.0'	15.0'	4.0'	-	10.1'	1 1/2" x 6" x 5' x 10' C
12	177+04.2	1.0'	2.5'	2.5'	-	2.5'	1 1/2" x 6" x 5' x 10' C
13	184+24.2	1.0'	4.0'	2.4'	-	3.144' (2)	1 1/2" x 6" x 5' x 10' C
14	233+73.5	1.0'	4.0'	2.5'	-	3.144' (2)	1 1/2" x 6" x 5' x 10' C

NOTE: All thrusting between thrust blocks and undisturbed ground is to be made with clean sand. Minimum compaction to be 85% by 1431K. 0.500 Method. Vertical in Compaction to be 300' psi. 28-729.

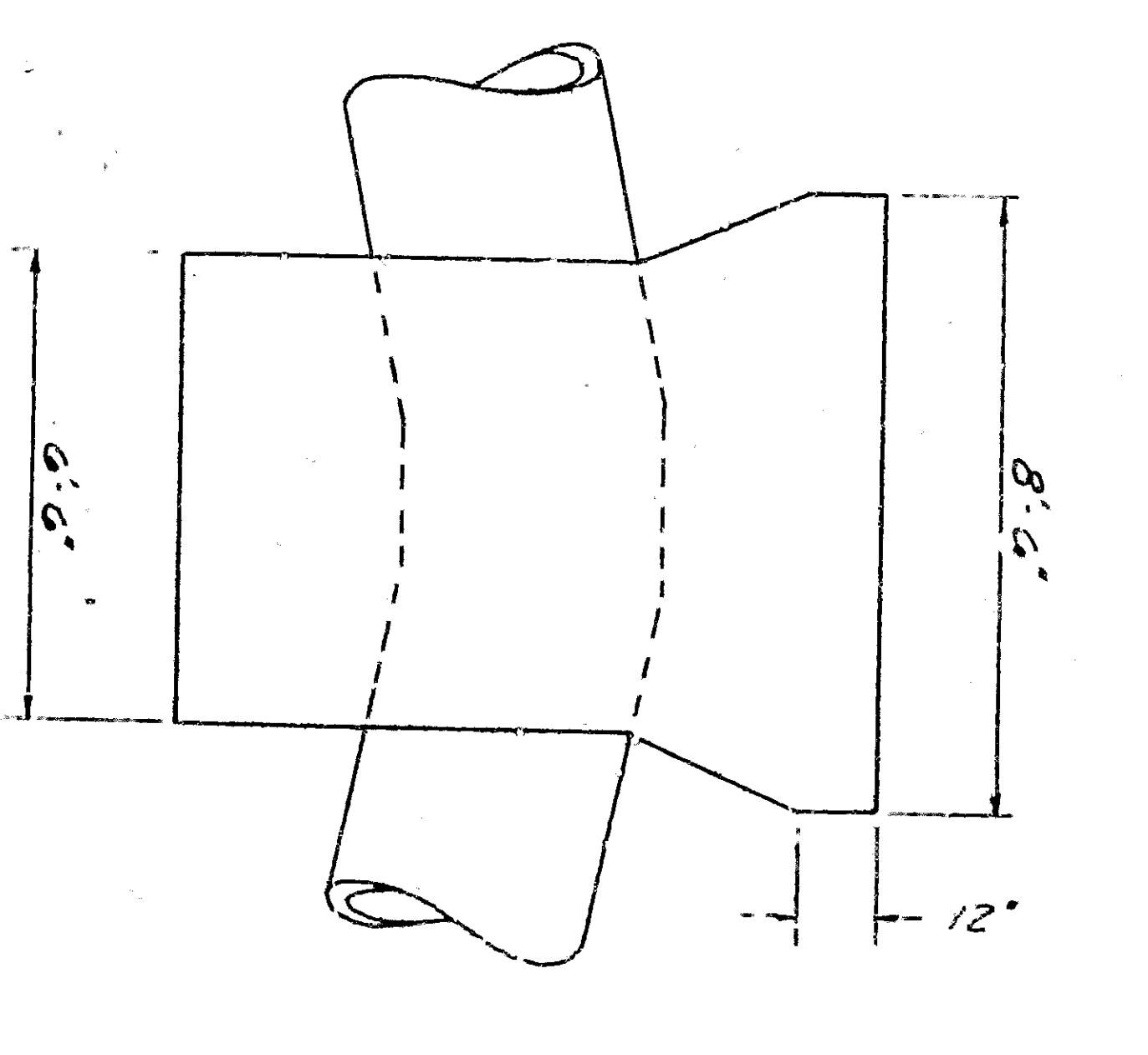
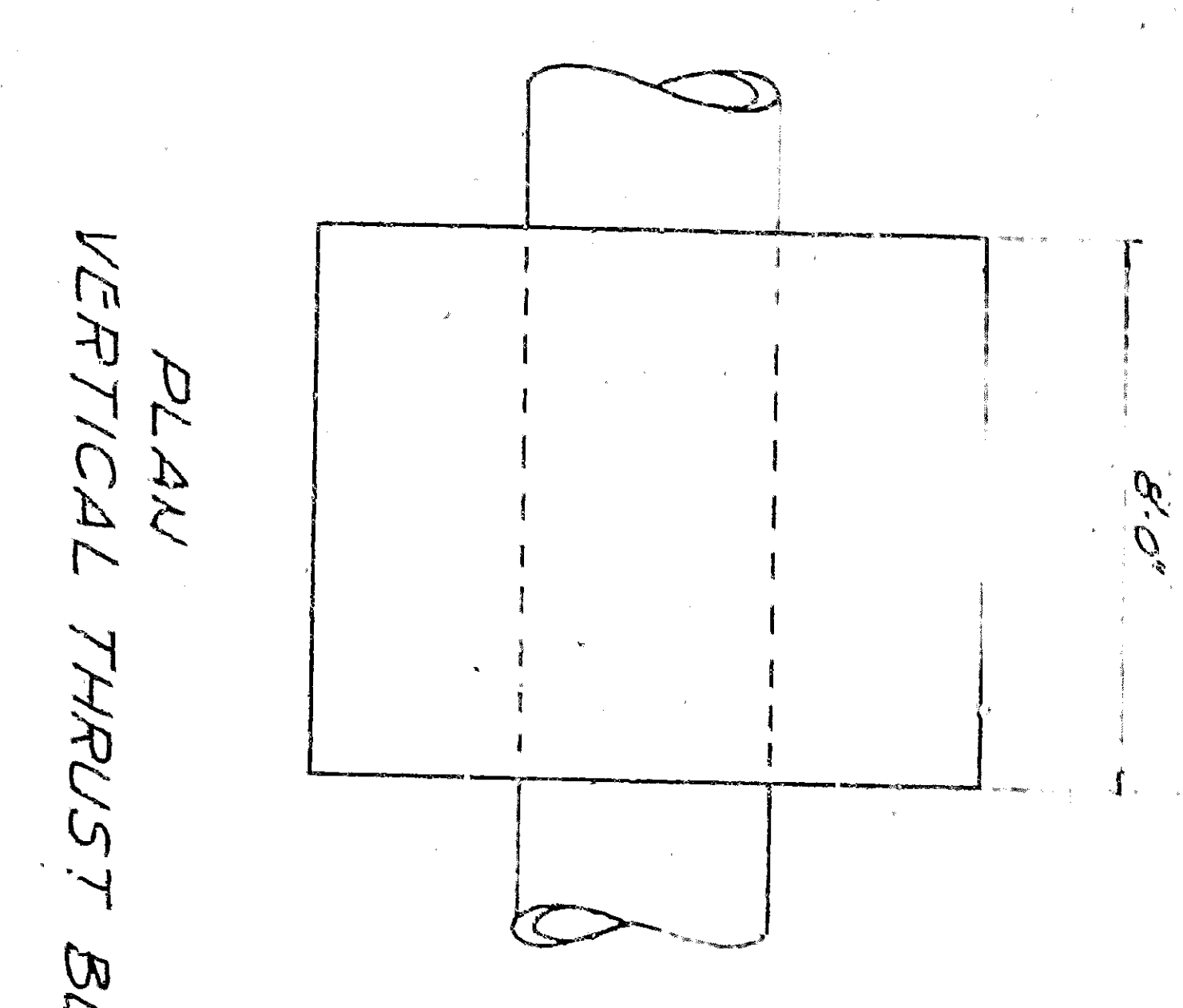

PLAN THRUST BLOCK #4  
STA 11+33.6  
Scale: 1/8" = 1'-0"

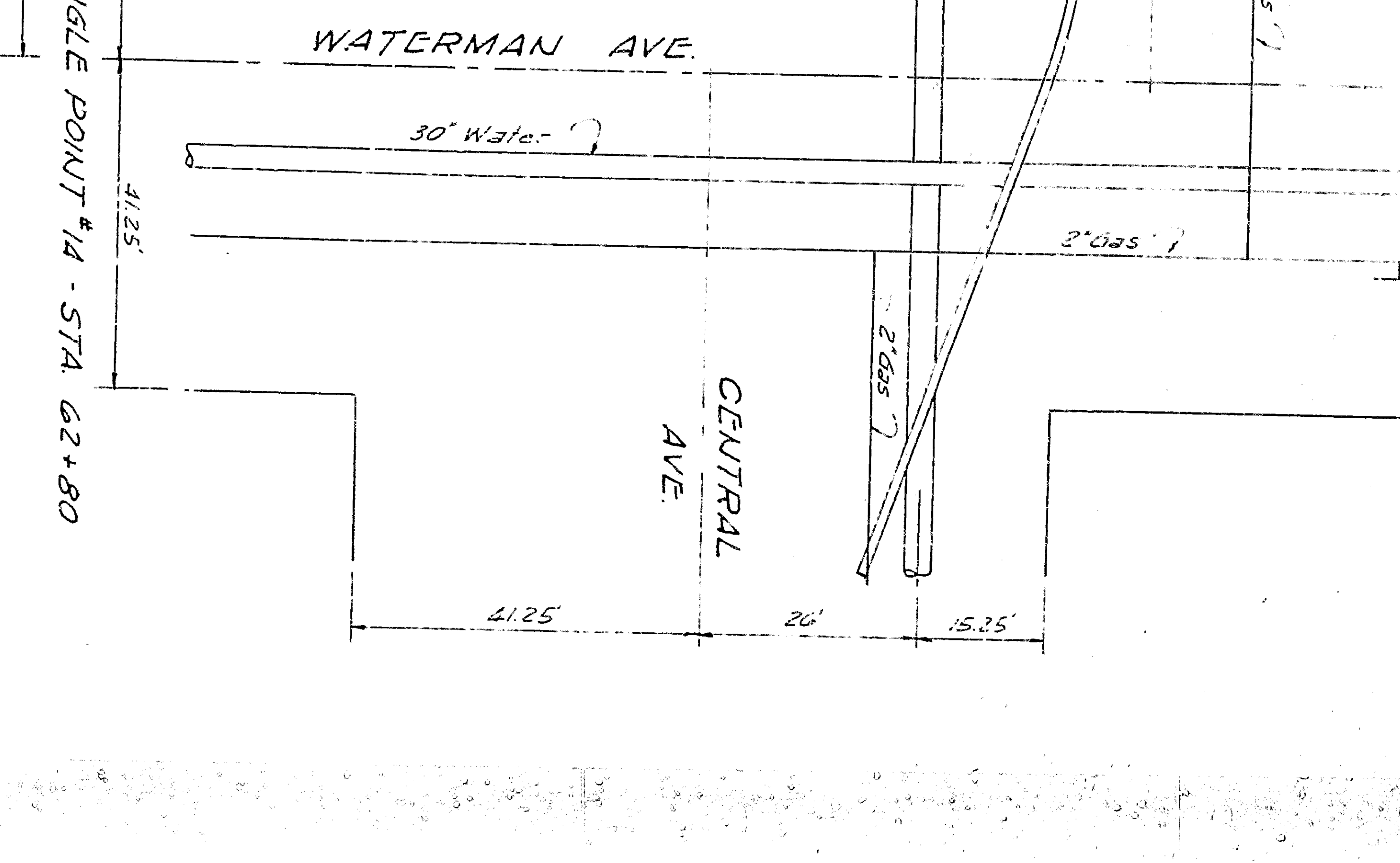
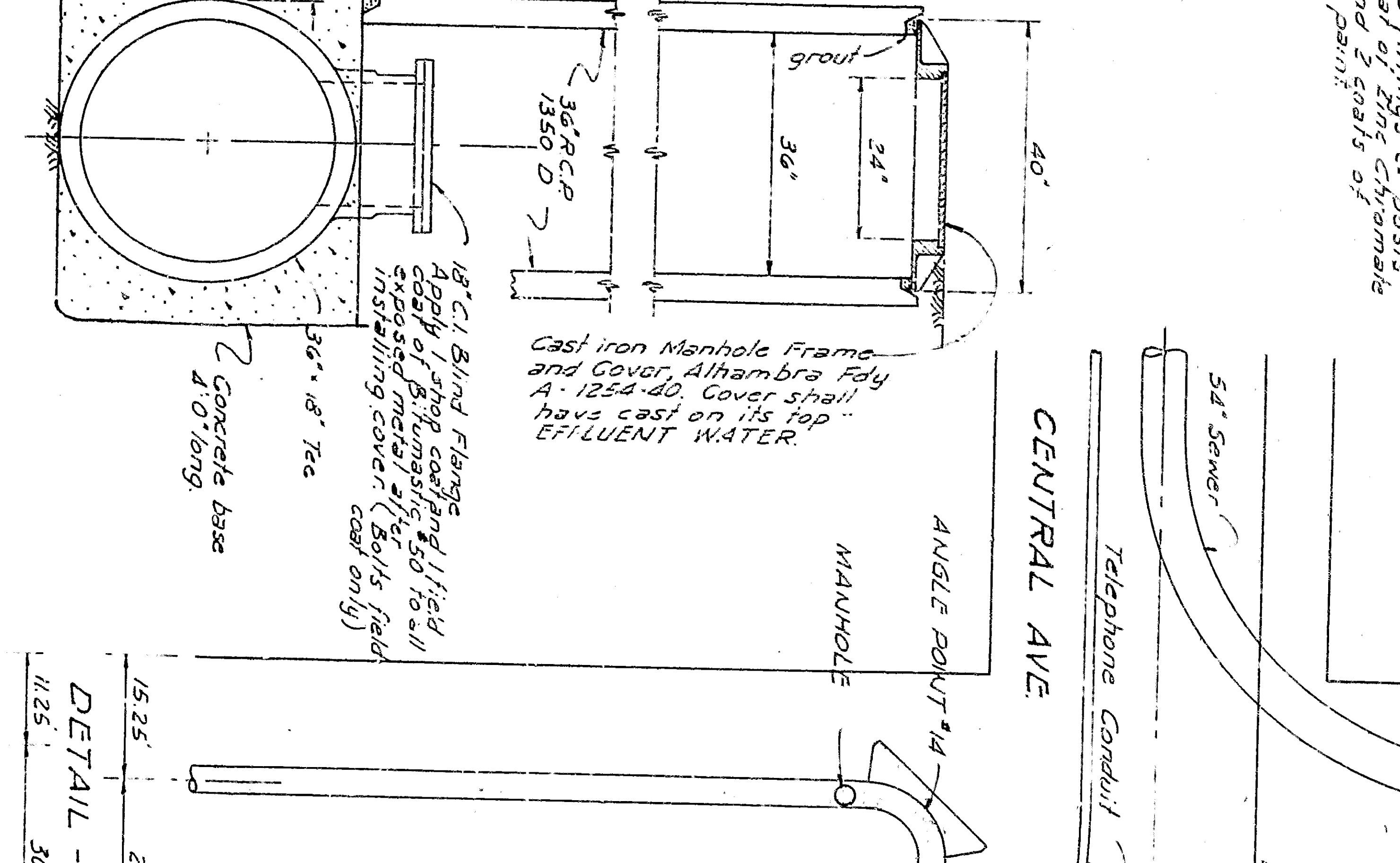
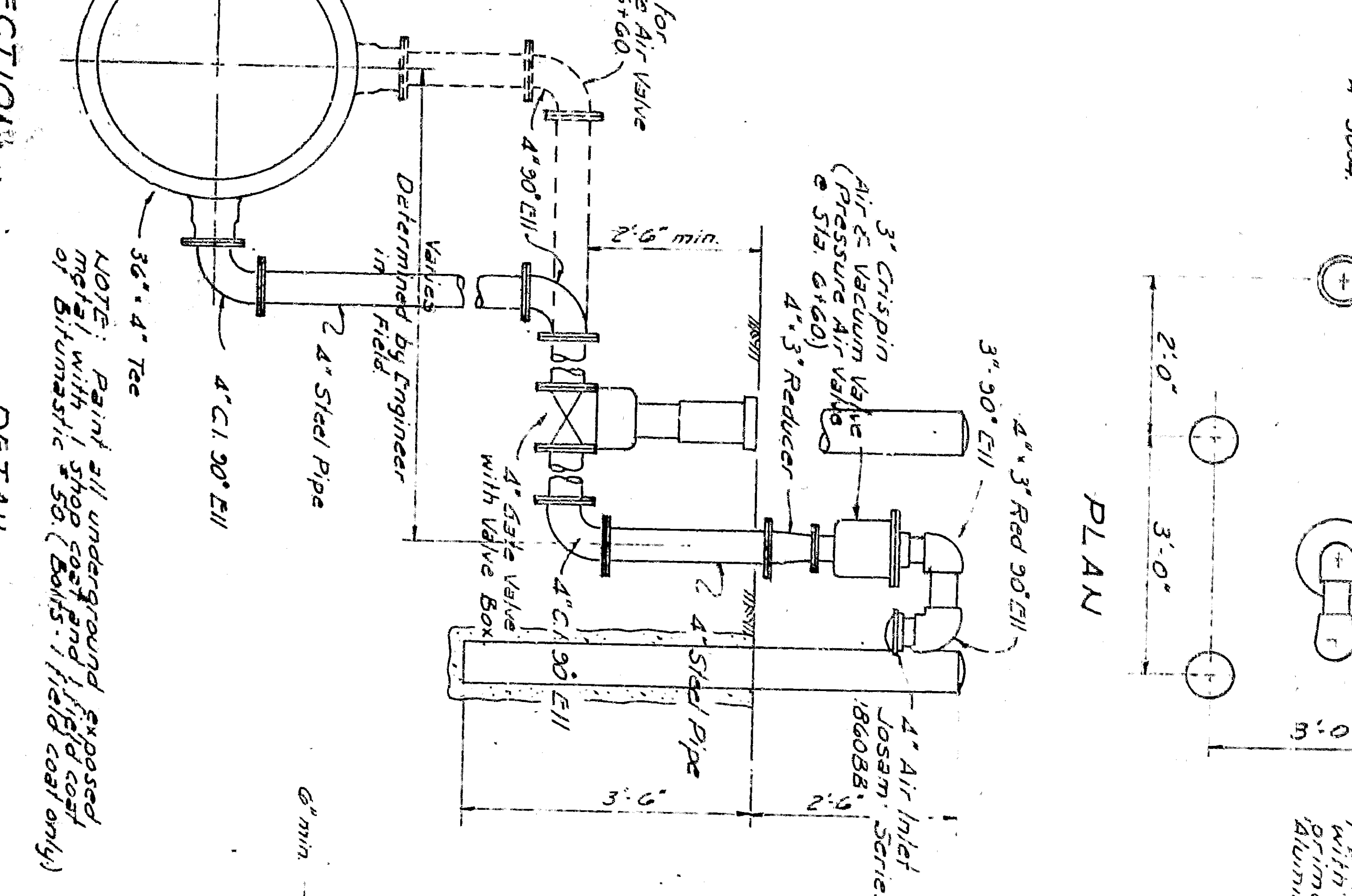
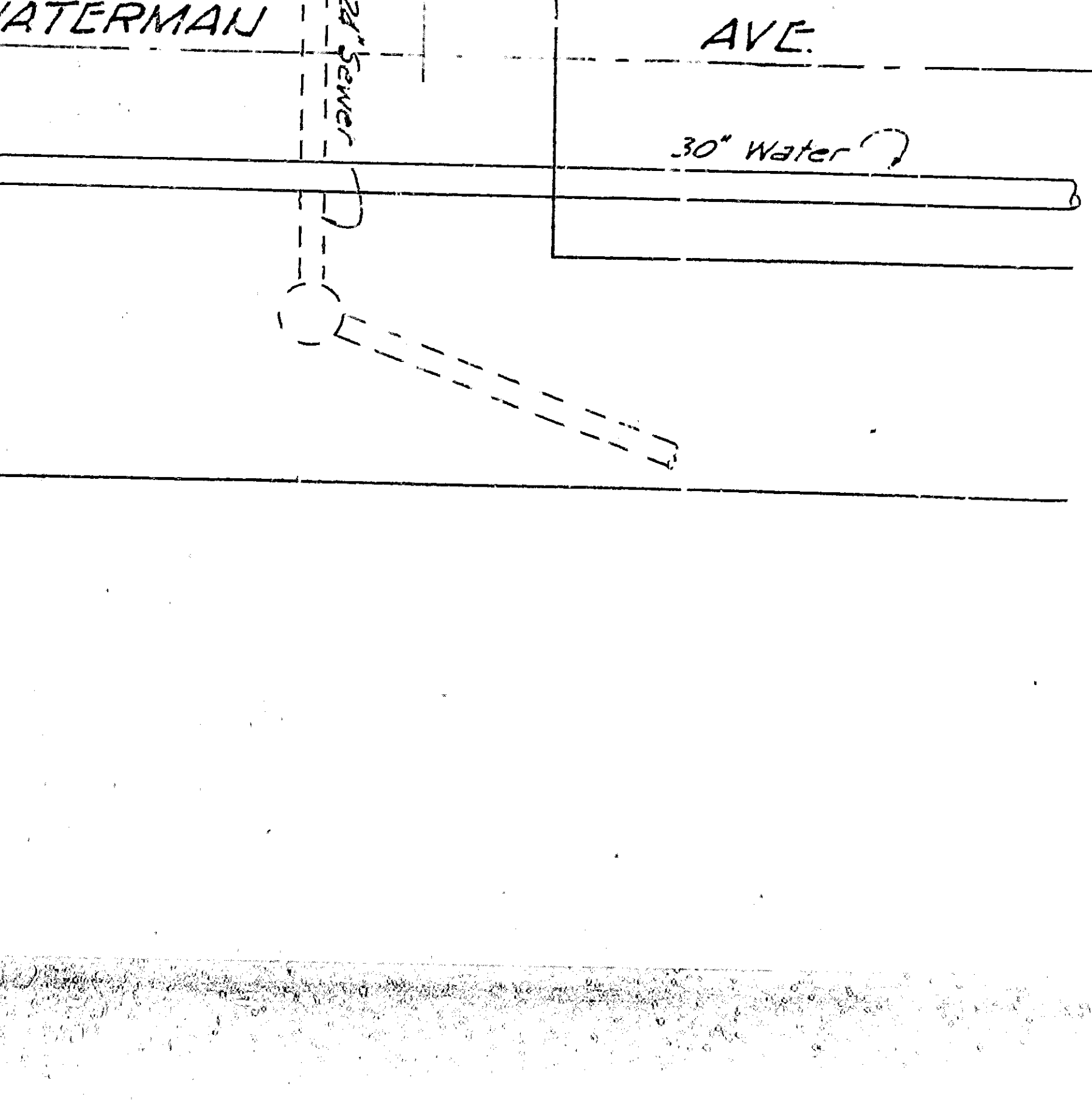
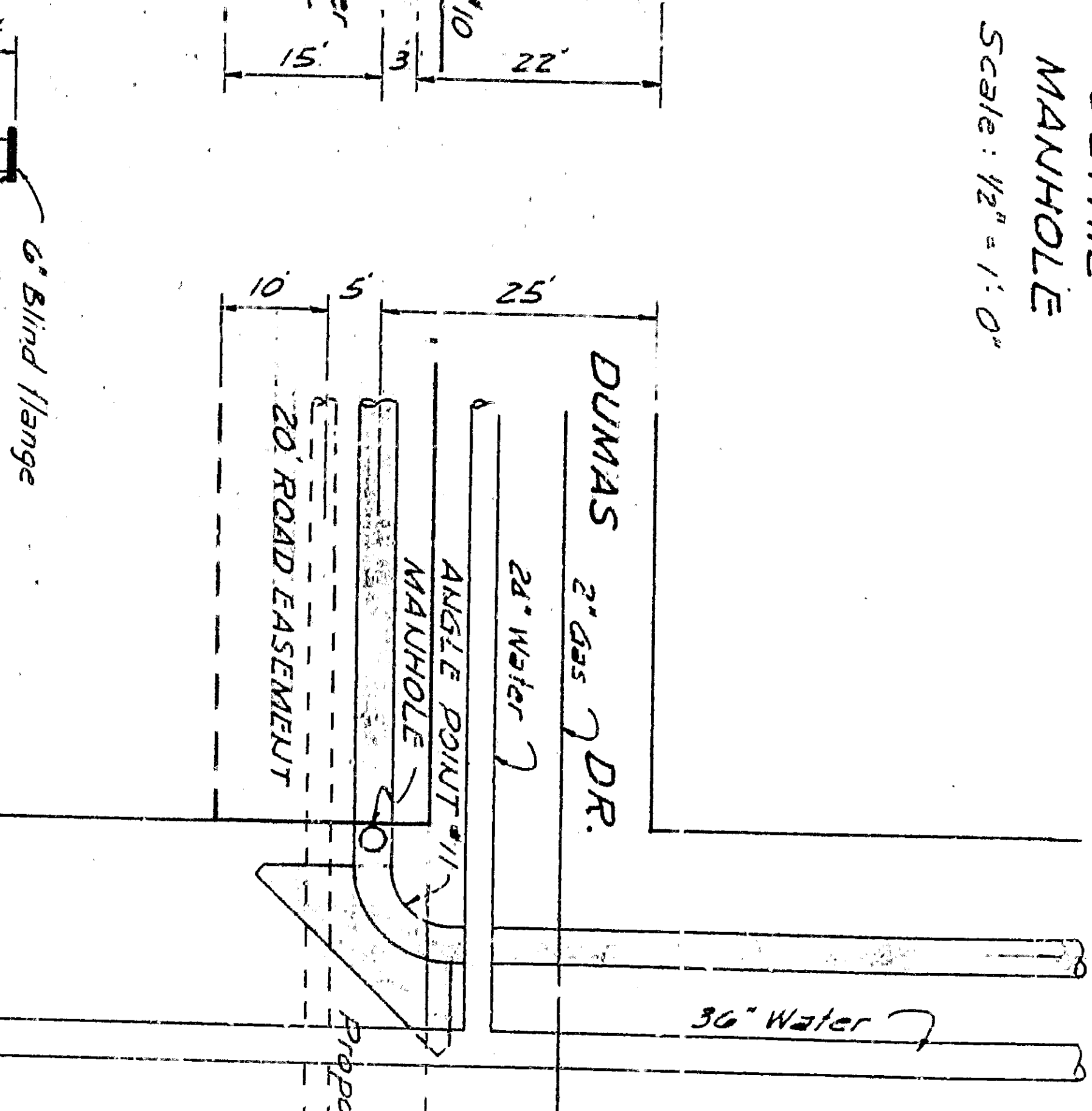
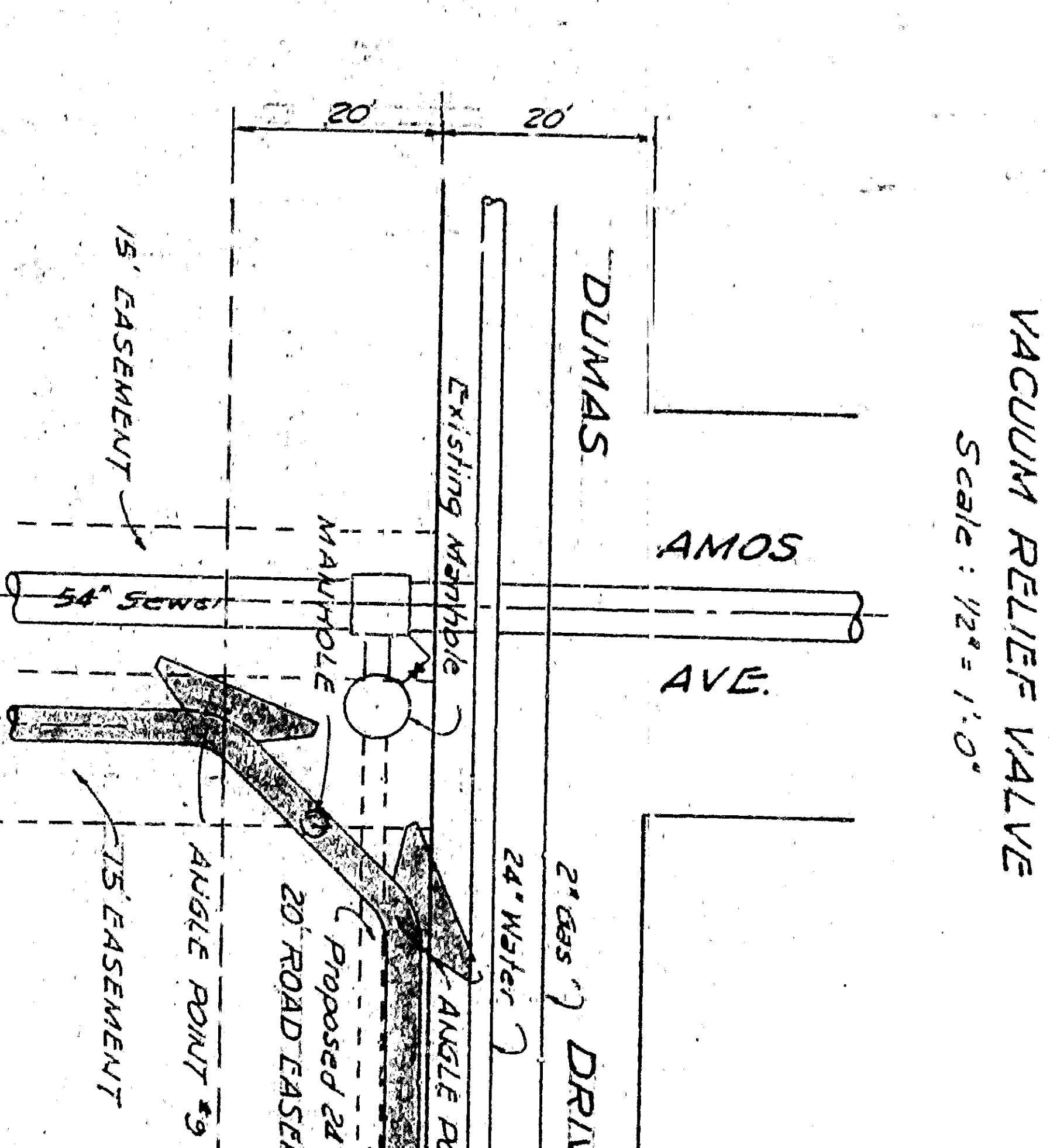
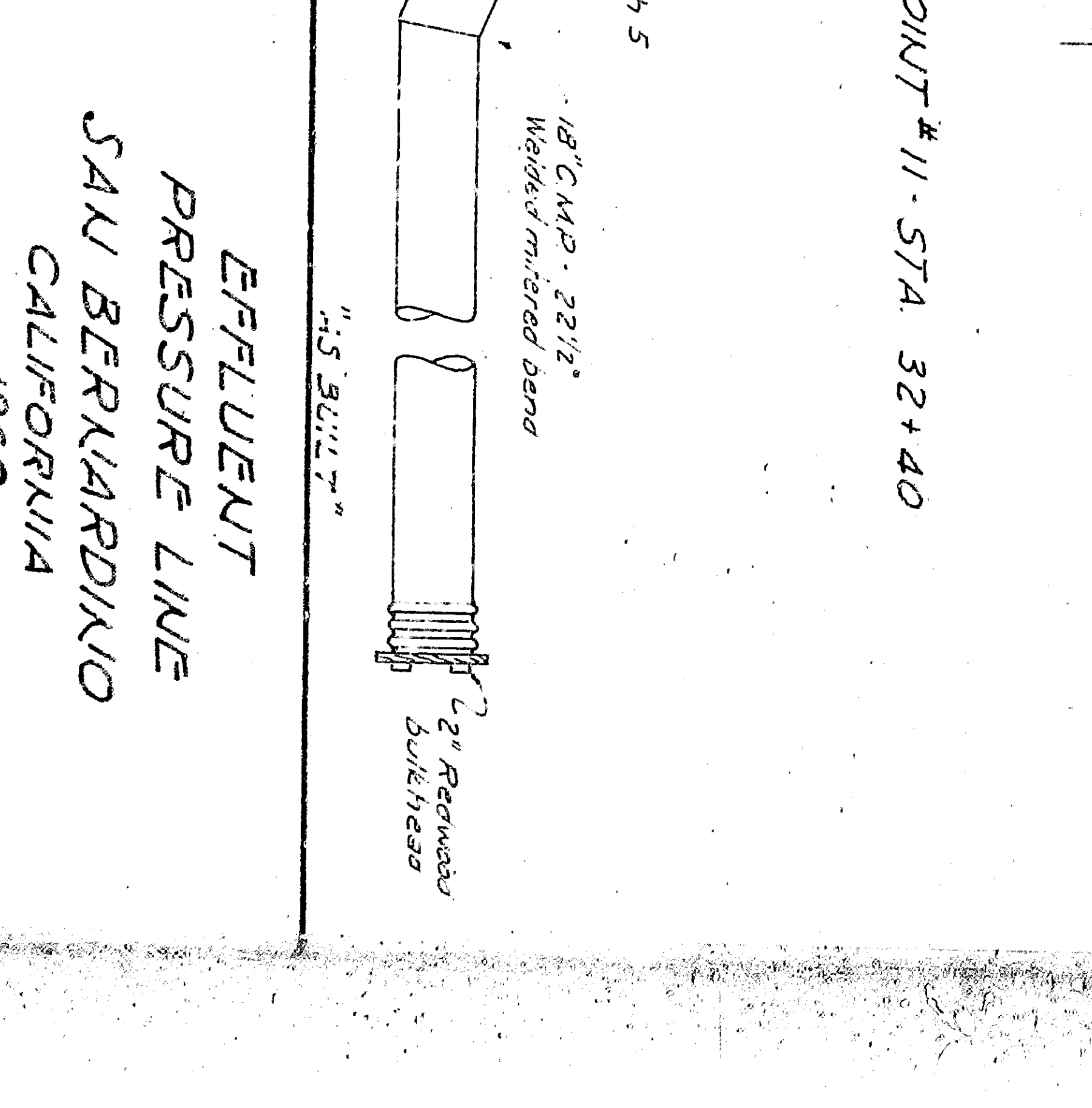
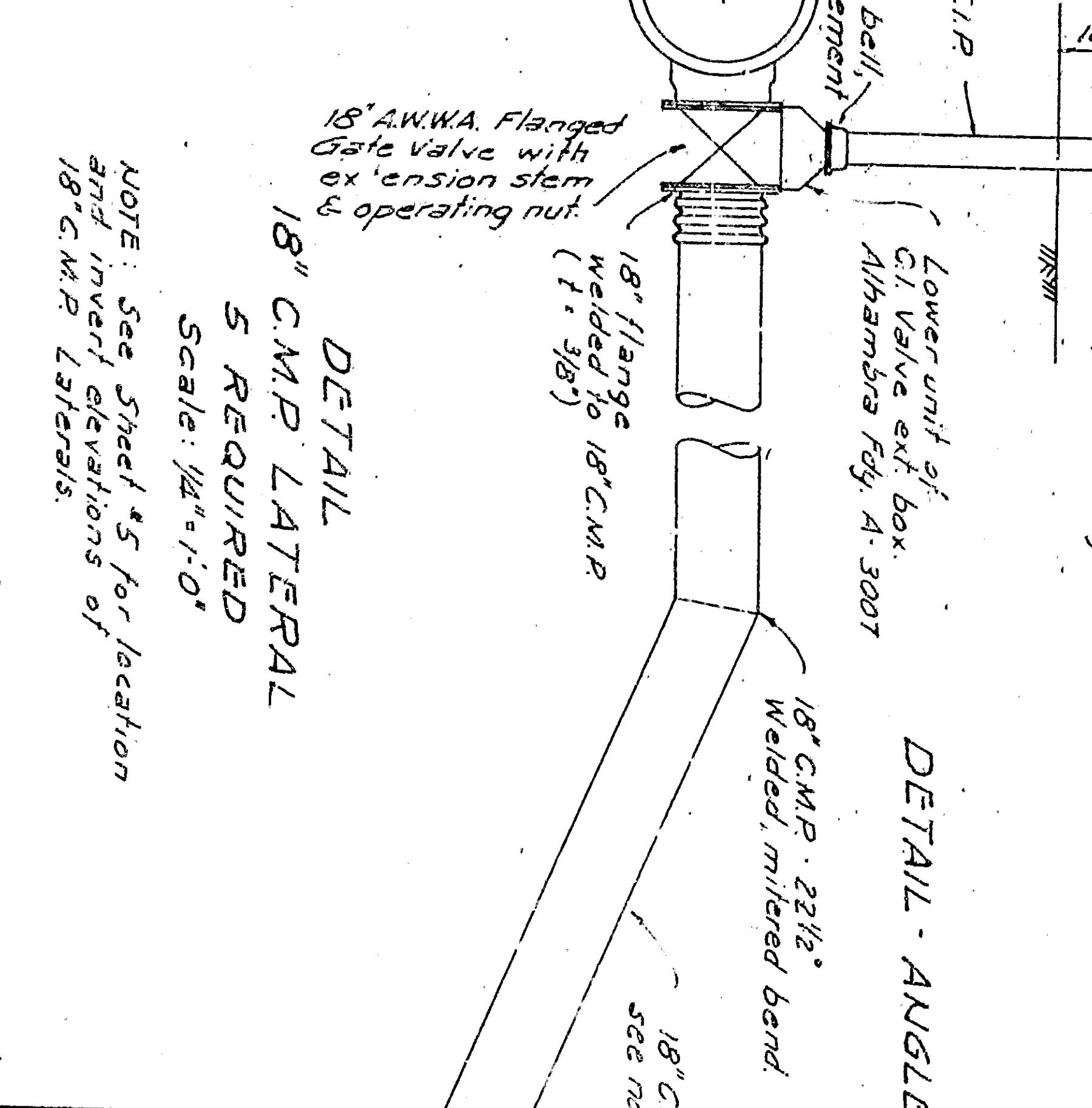
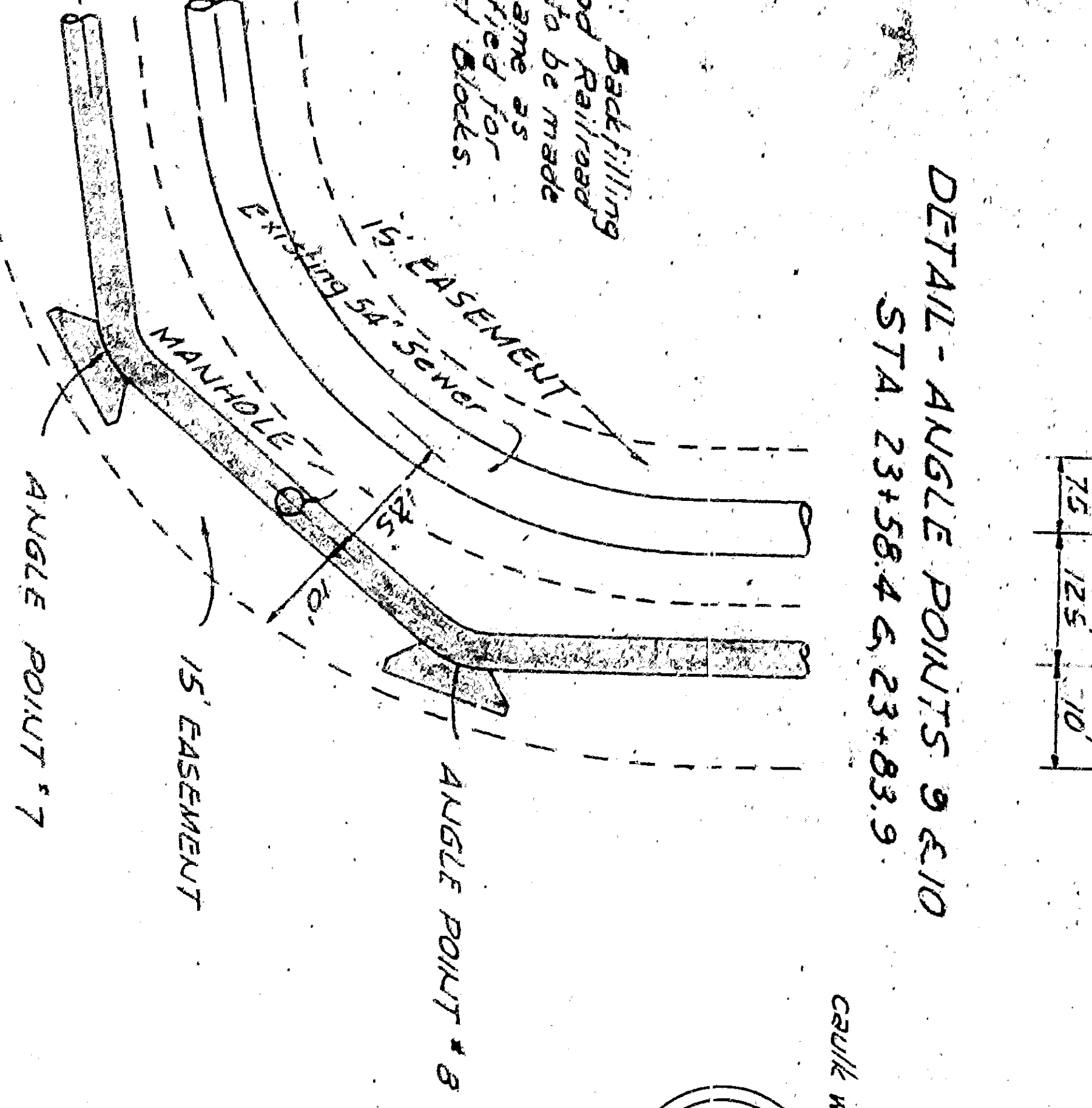
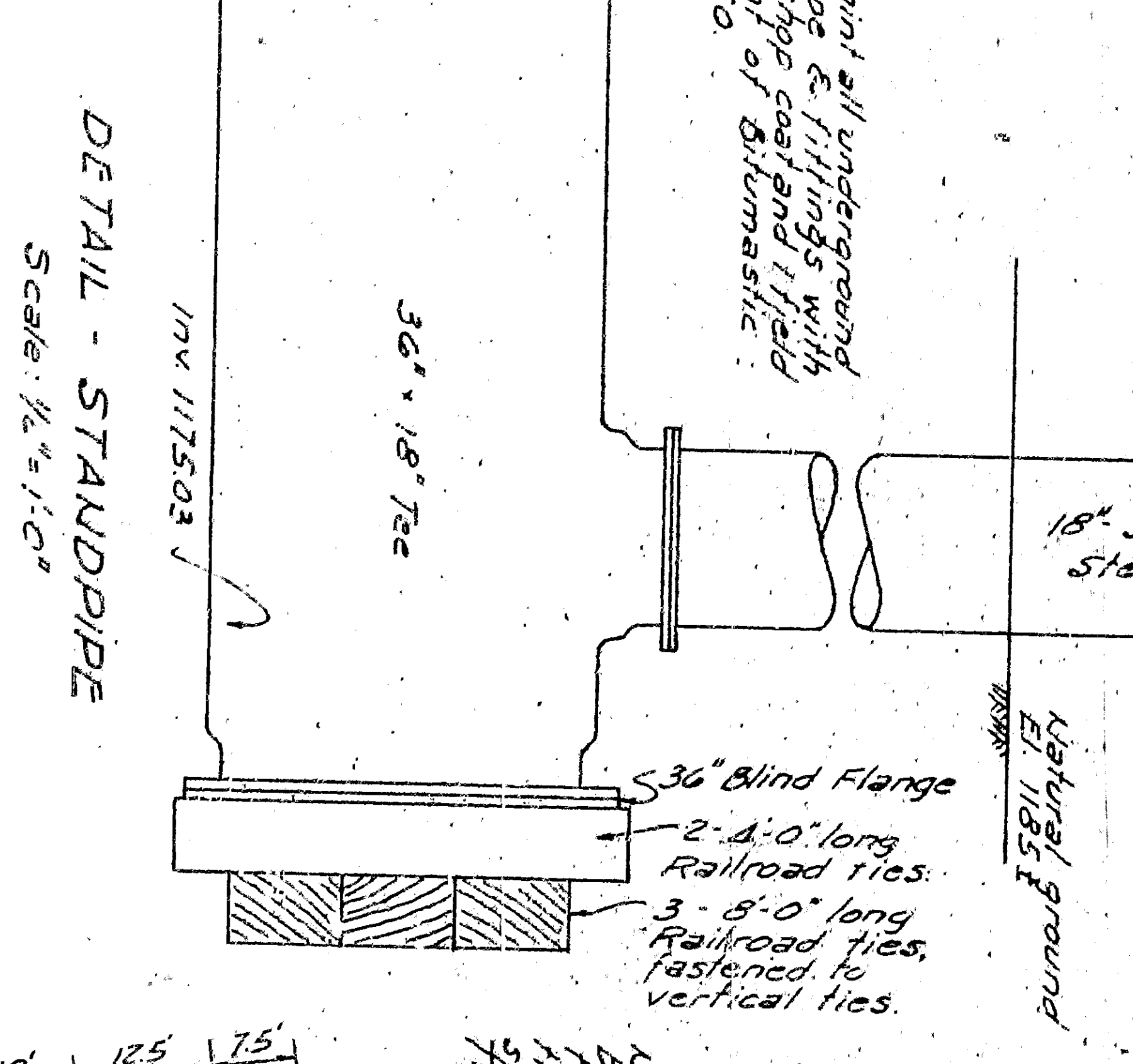
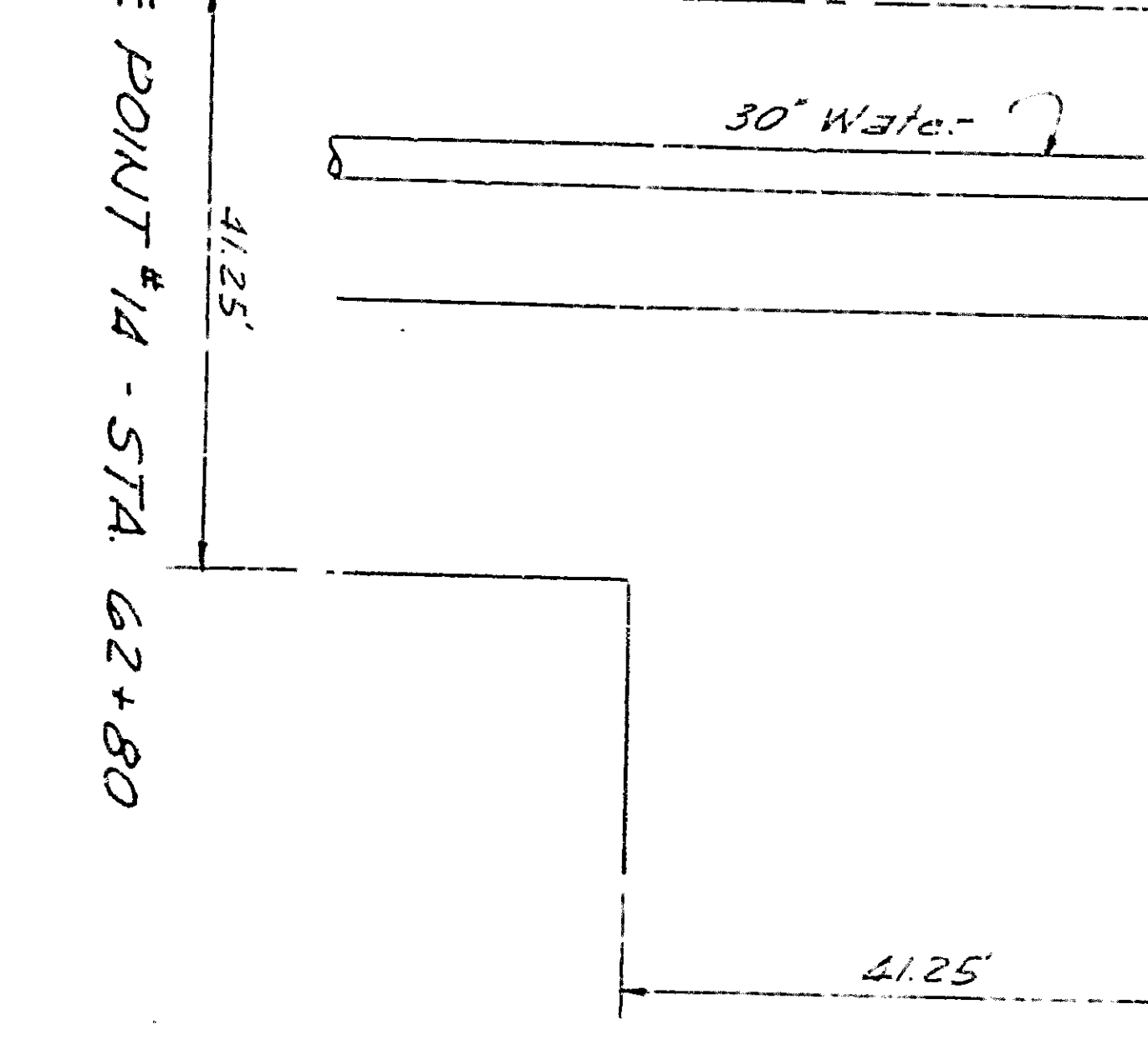
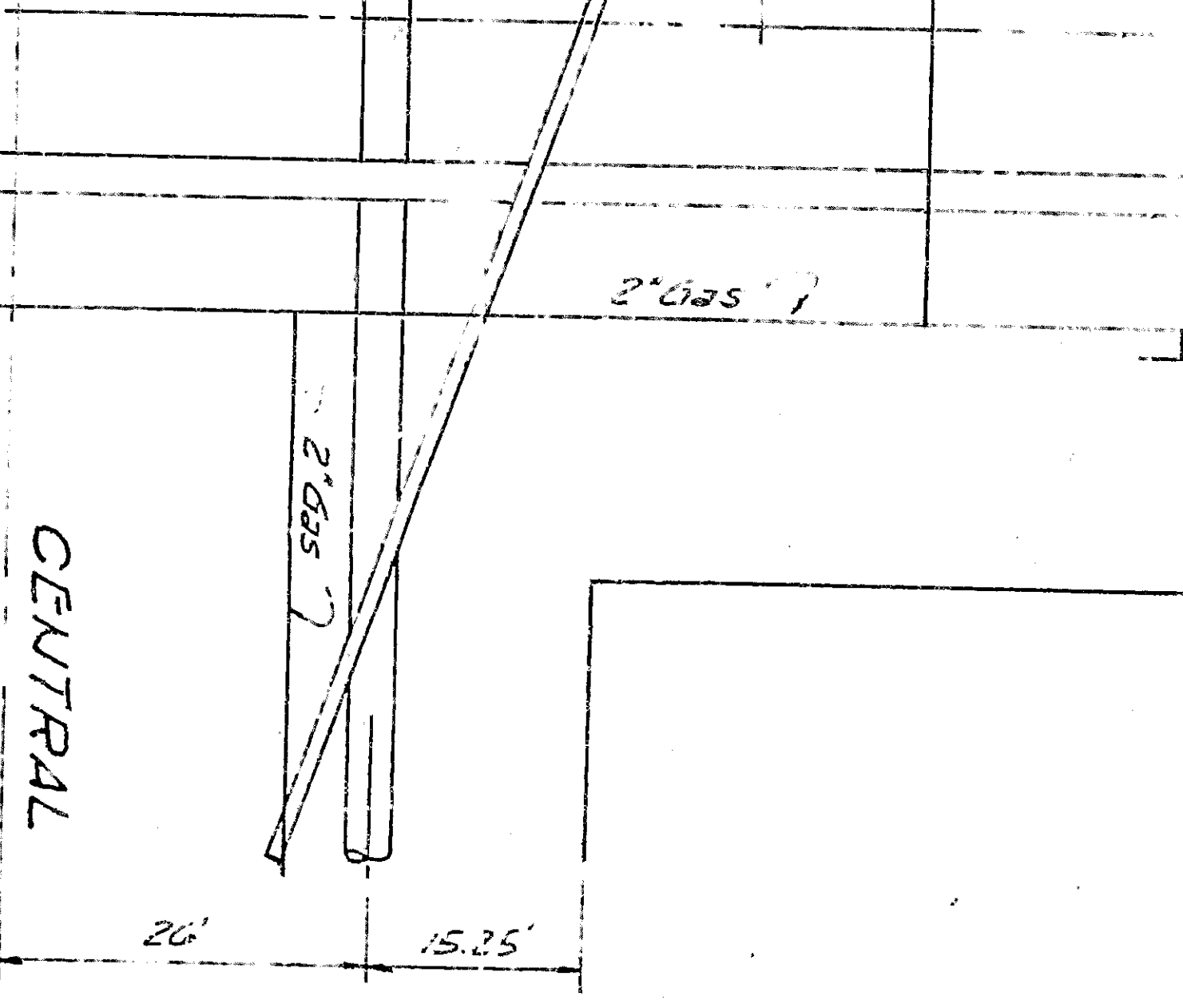
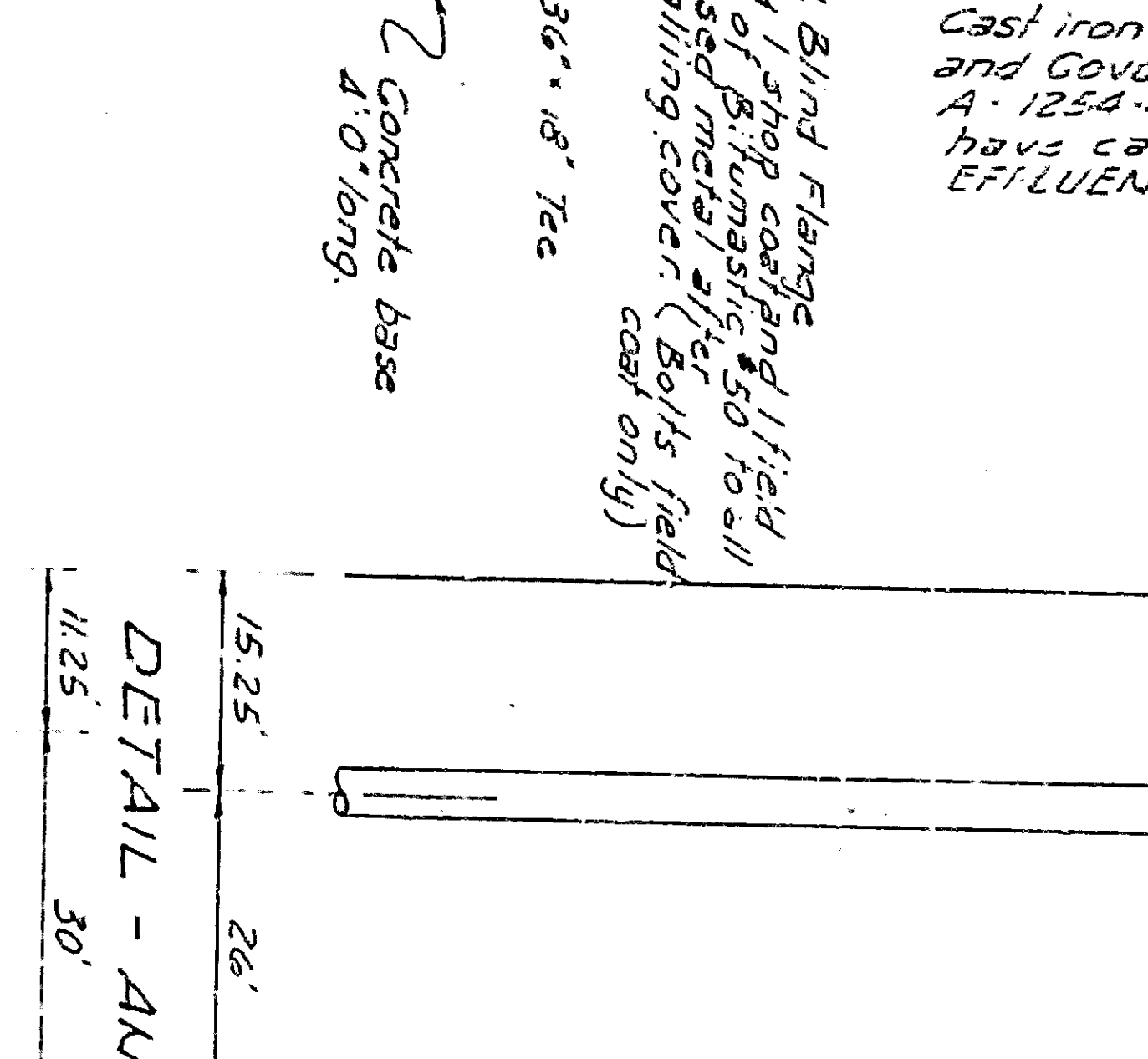
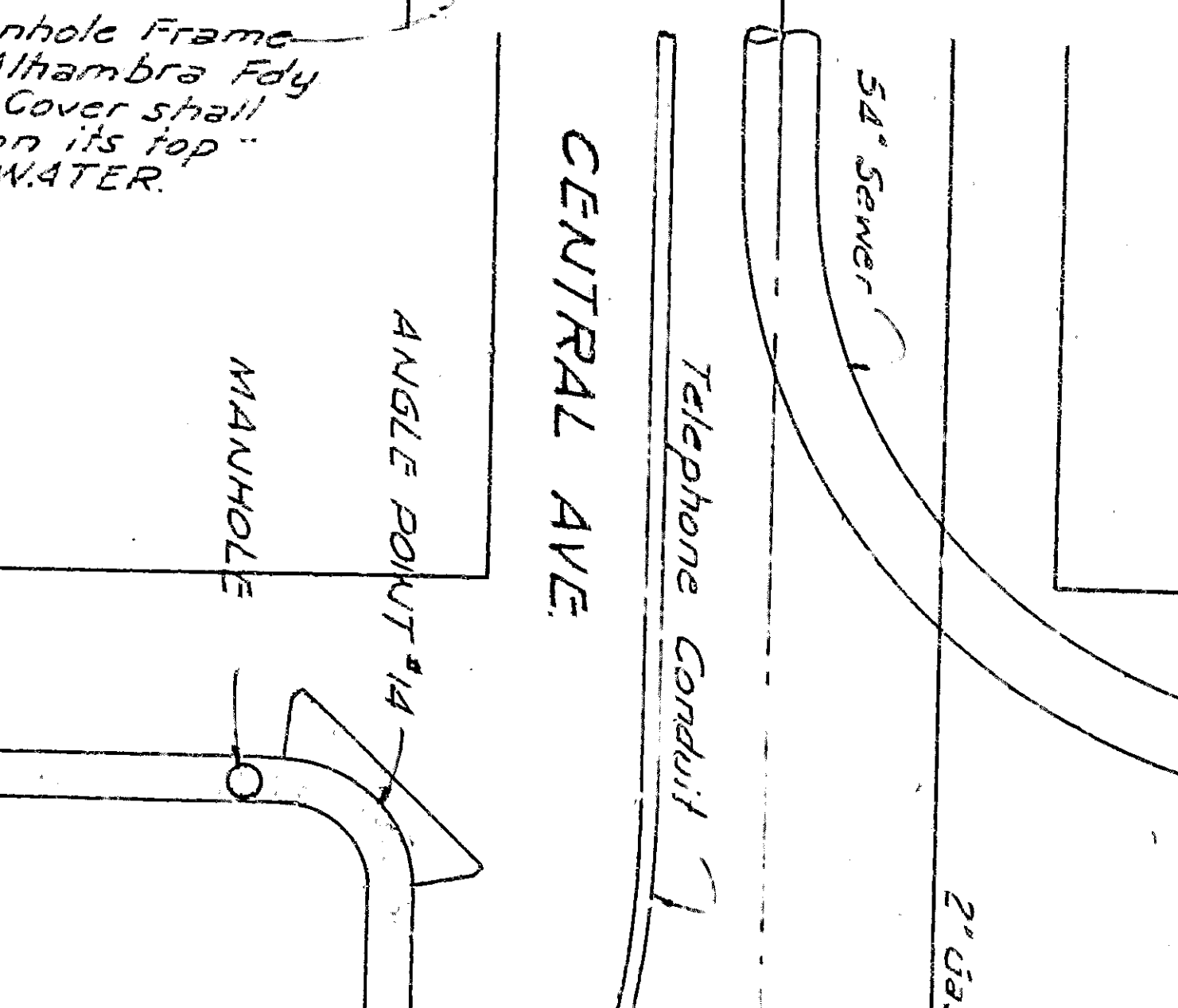
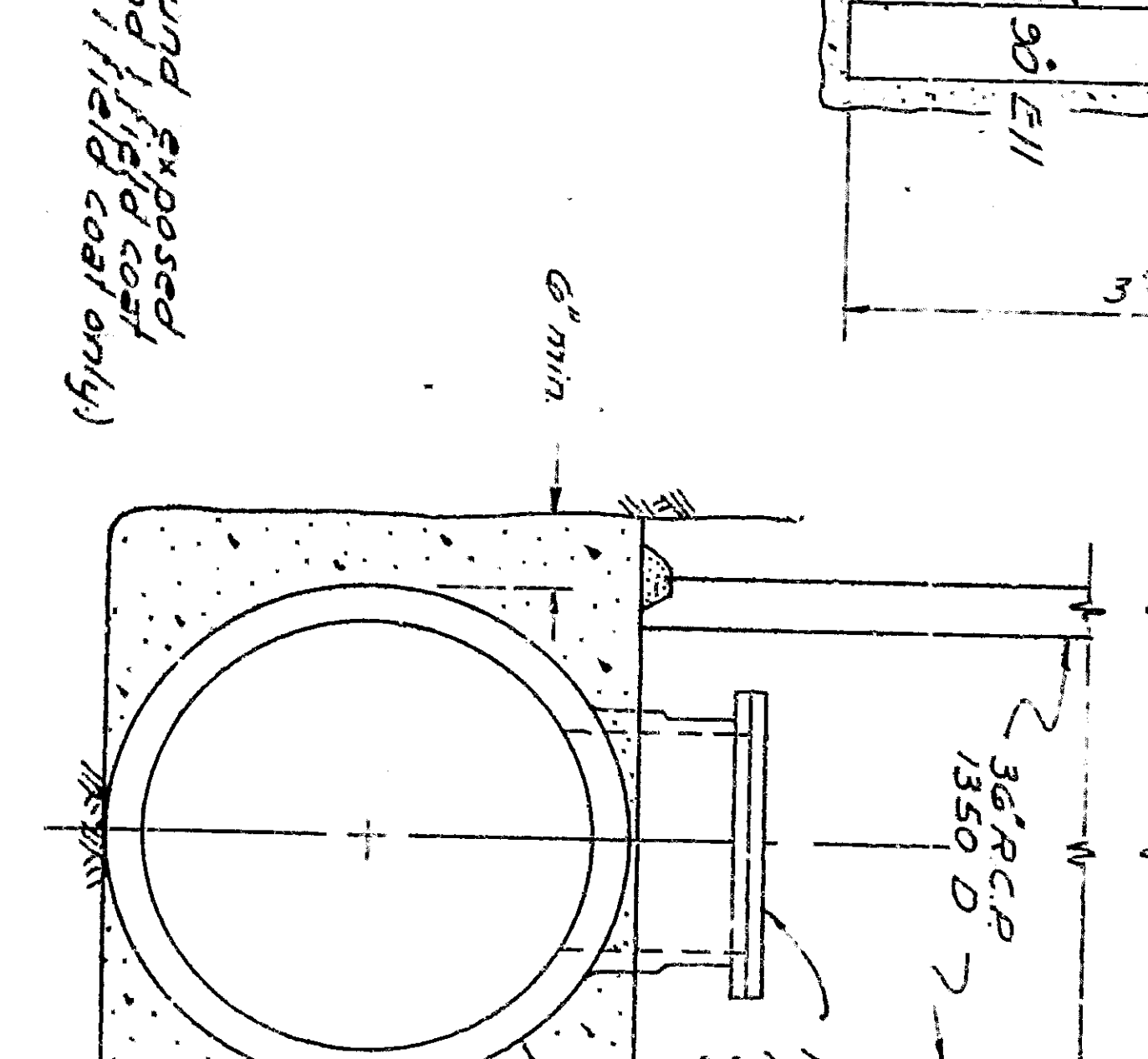
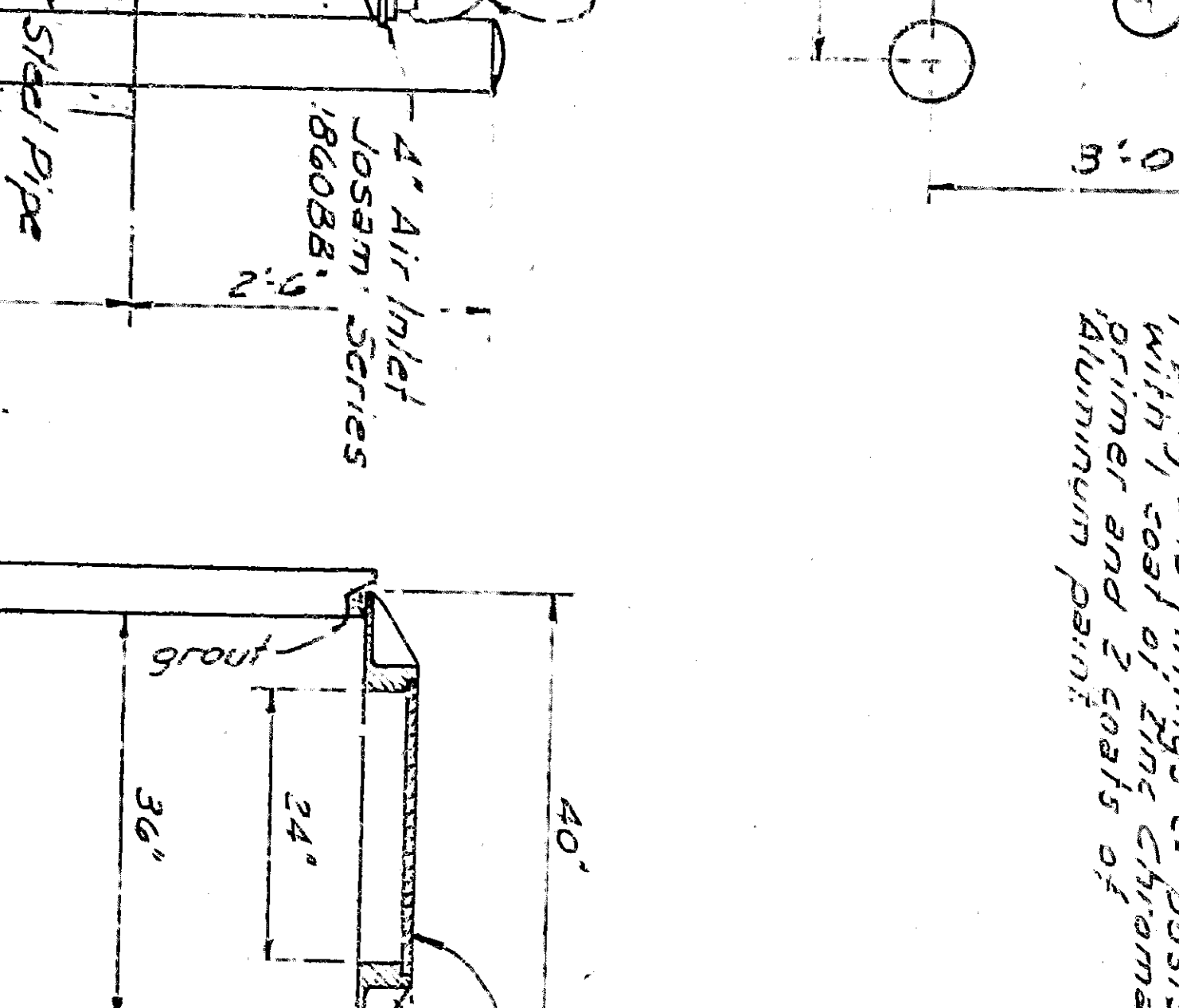
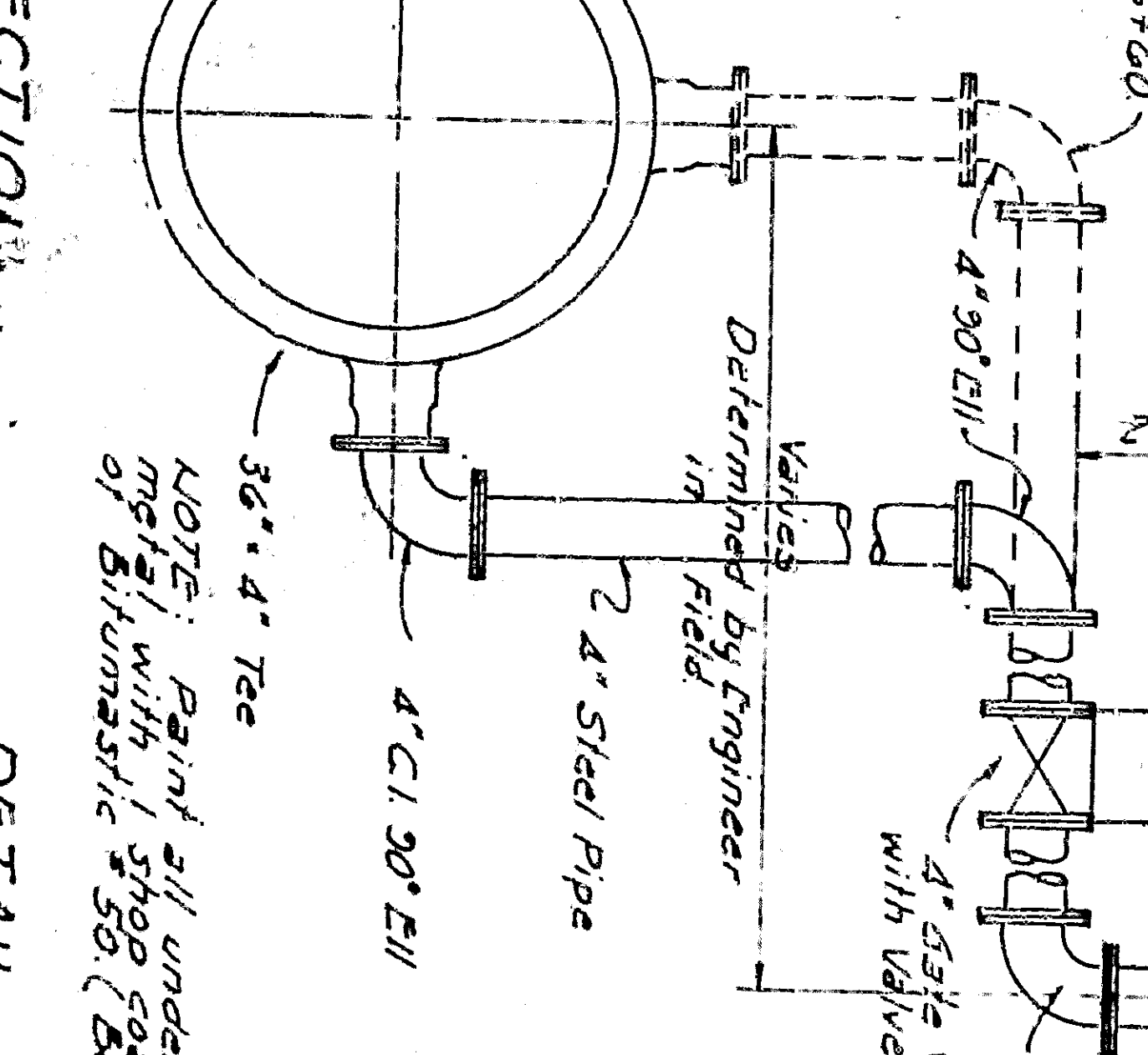
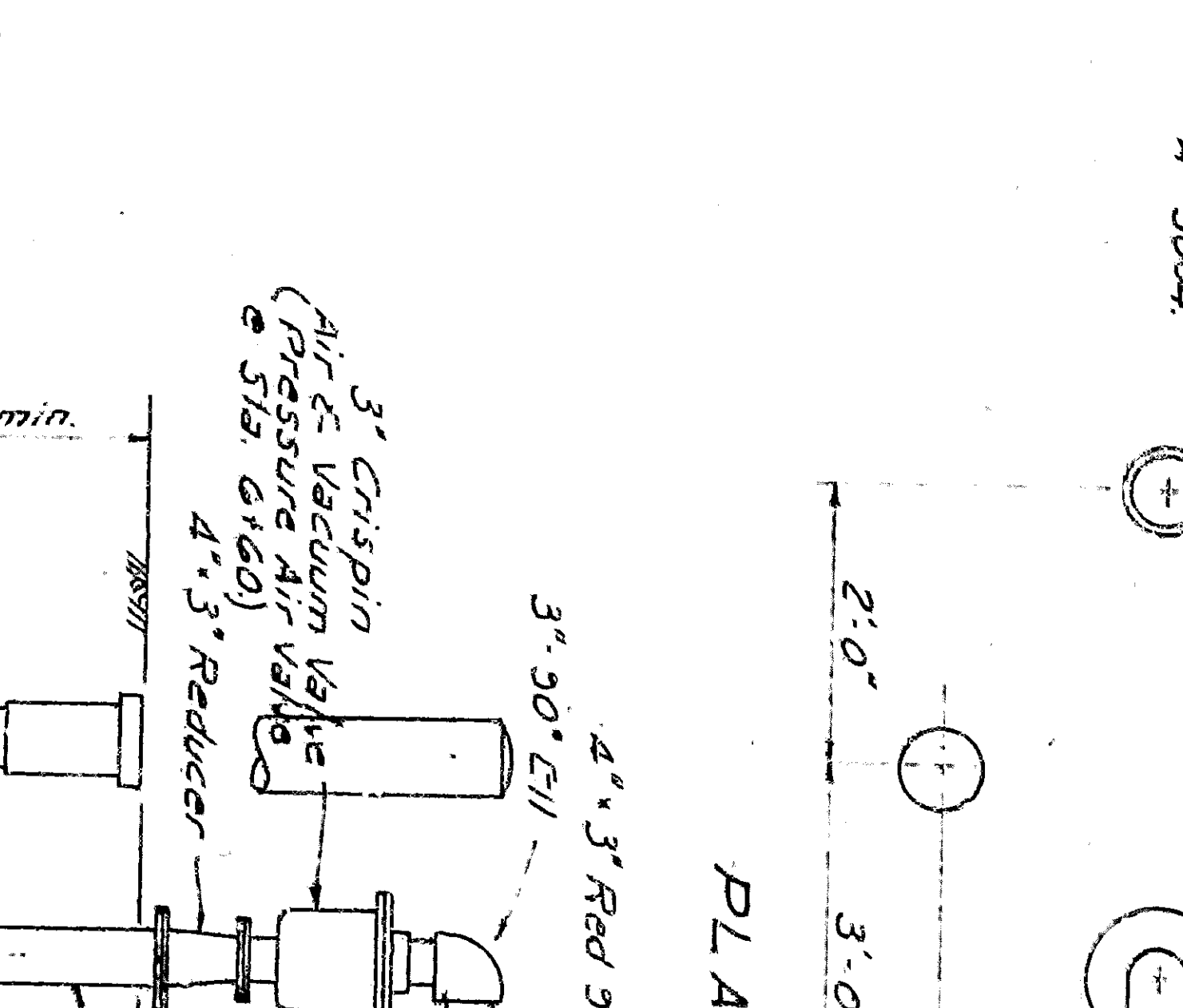
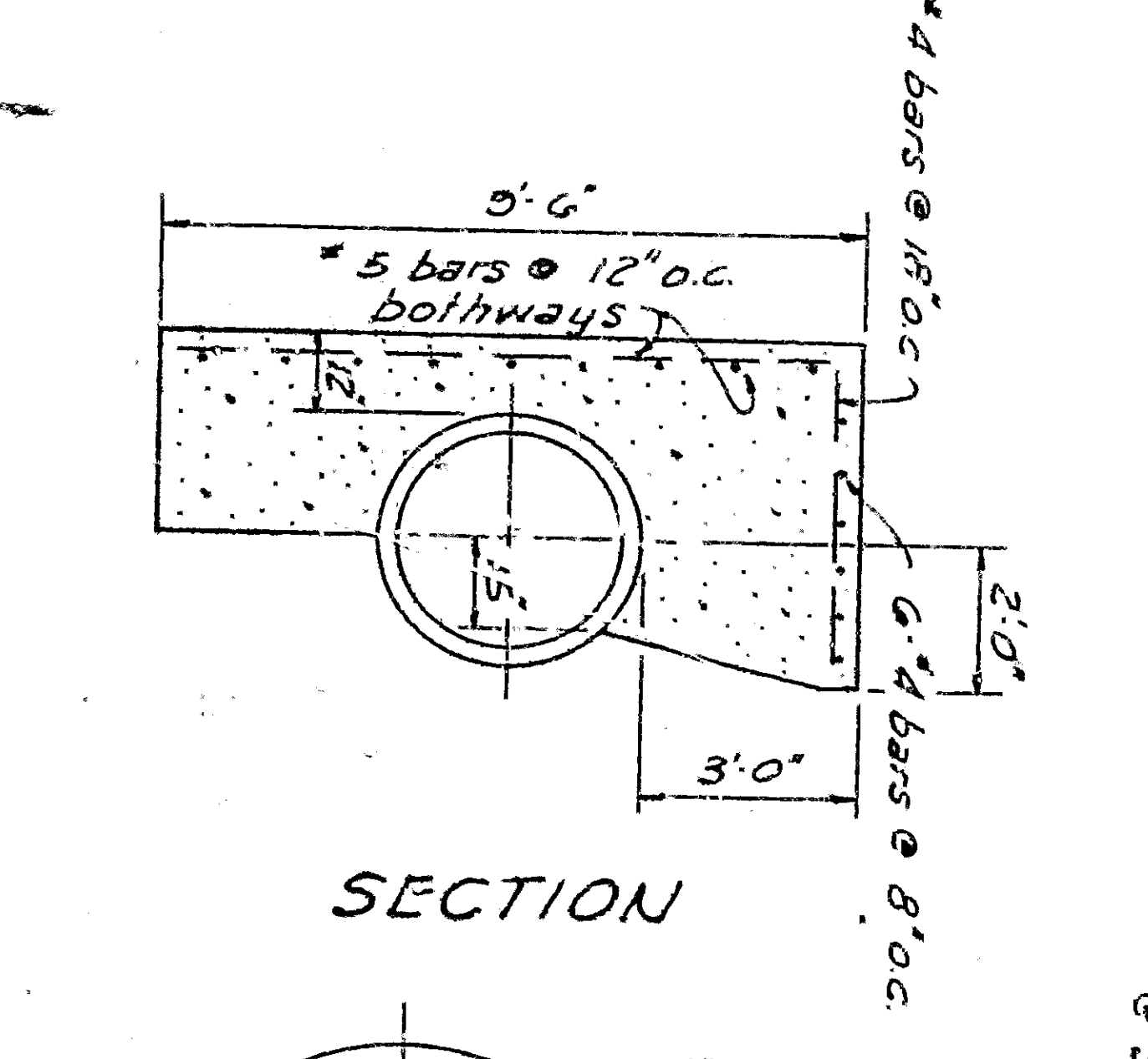
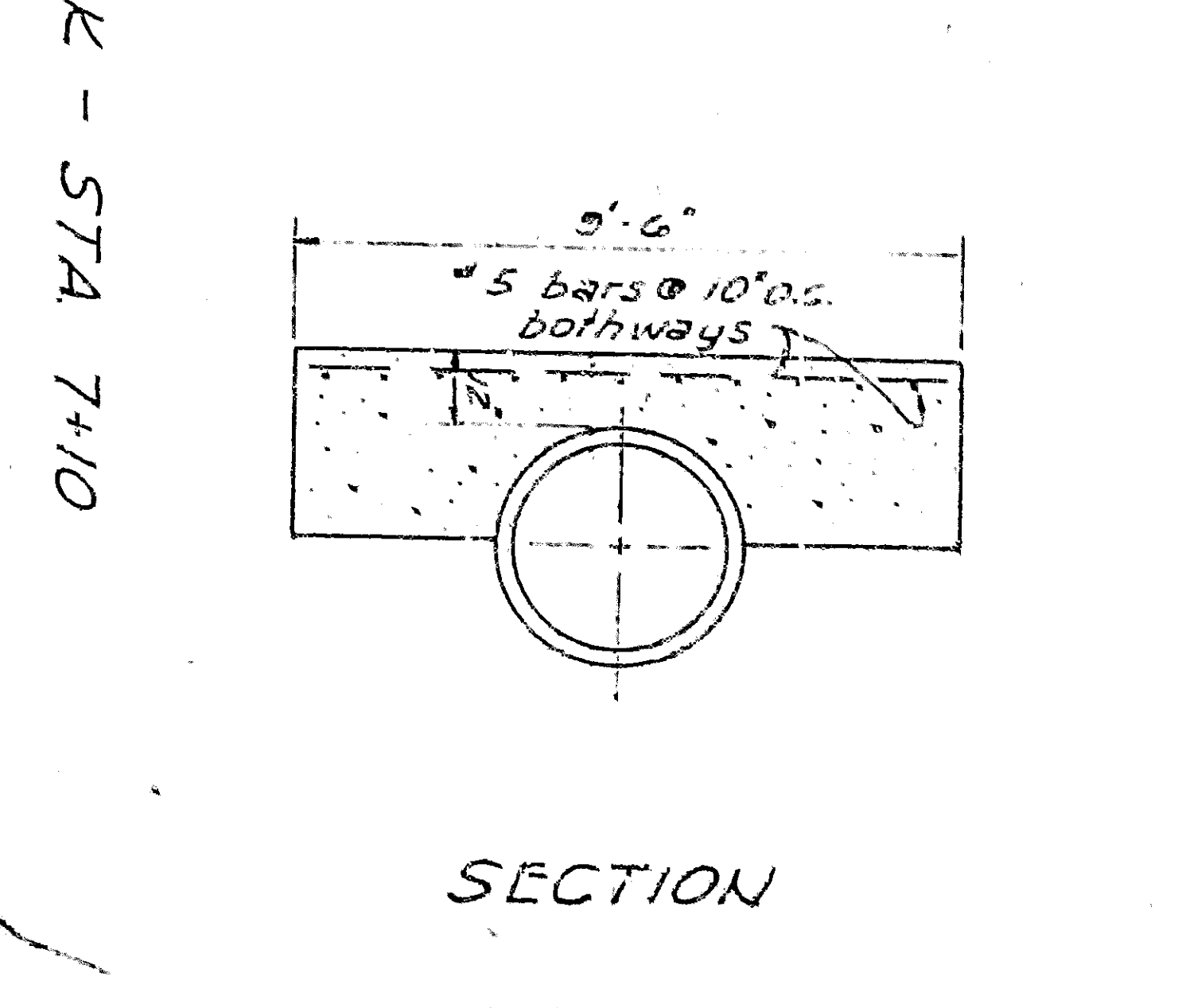

EPFLUENT PRESSURE LINE  
SAU BERRIARDINO  
CALIFORNIA  
1960  
CURTIS ENGINEERING COMPANY  
CONSULTING ENGINEERS

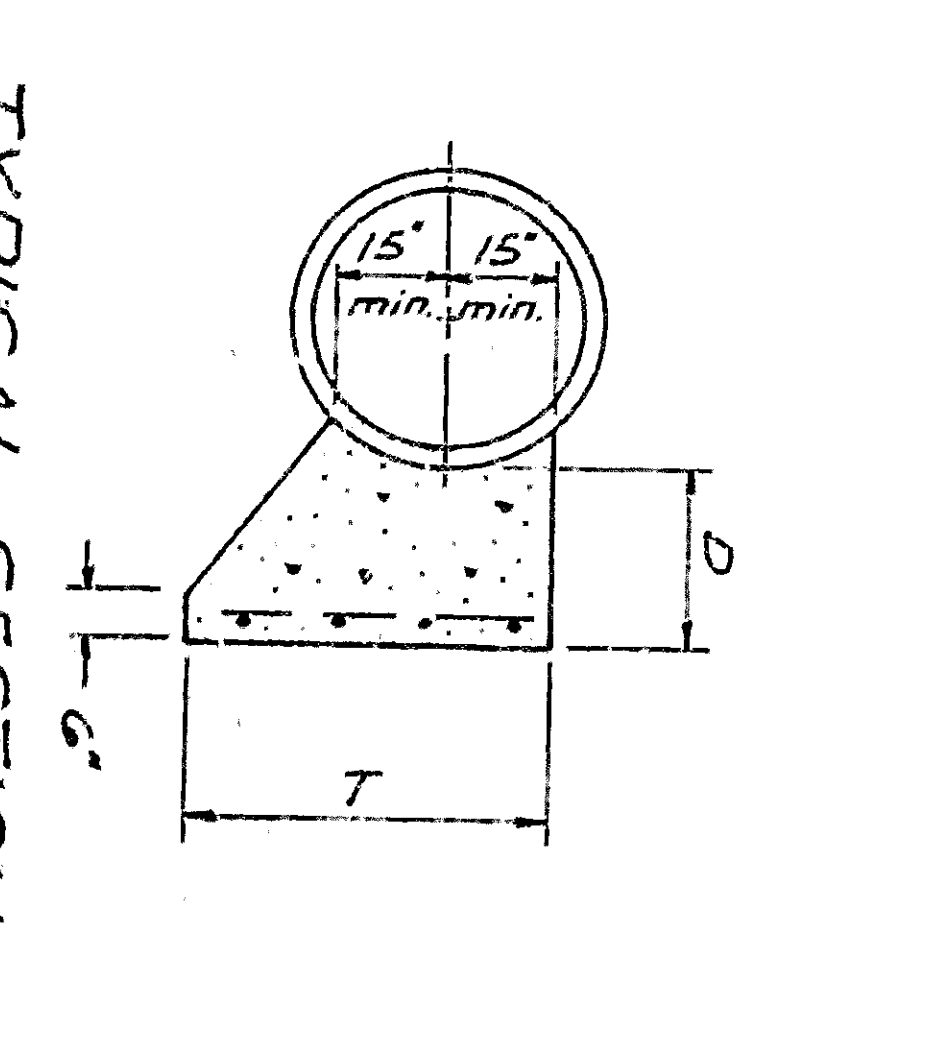
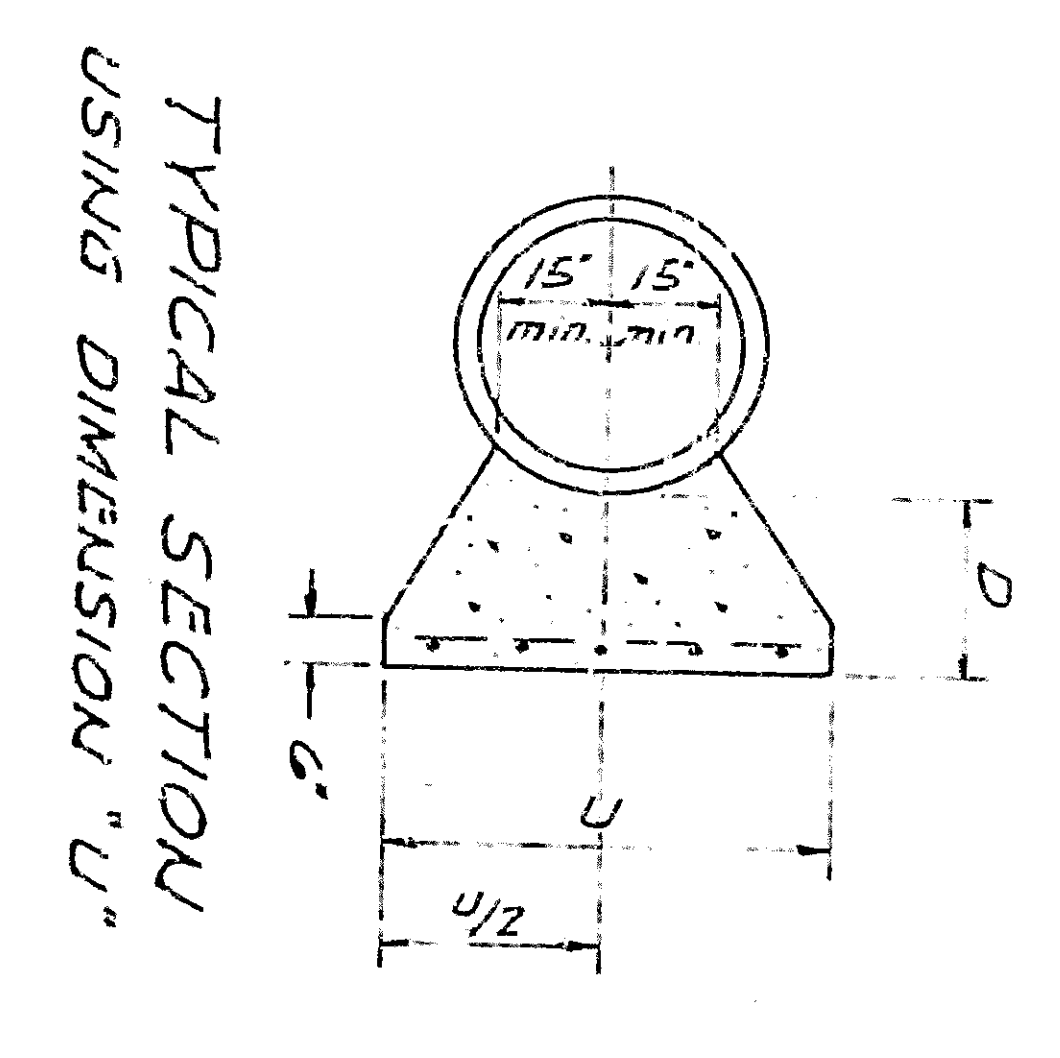
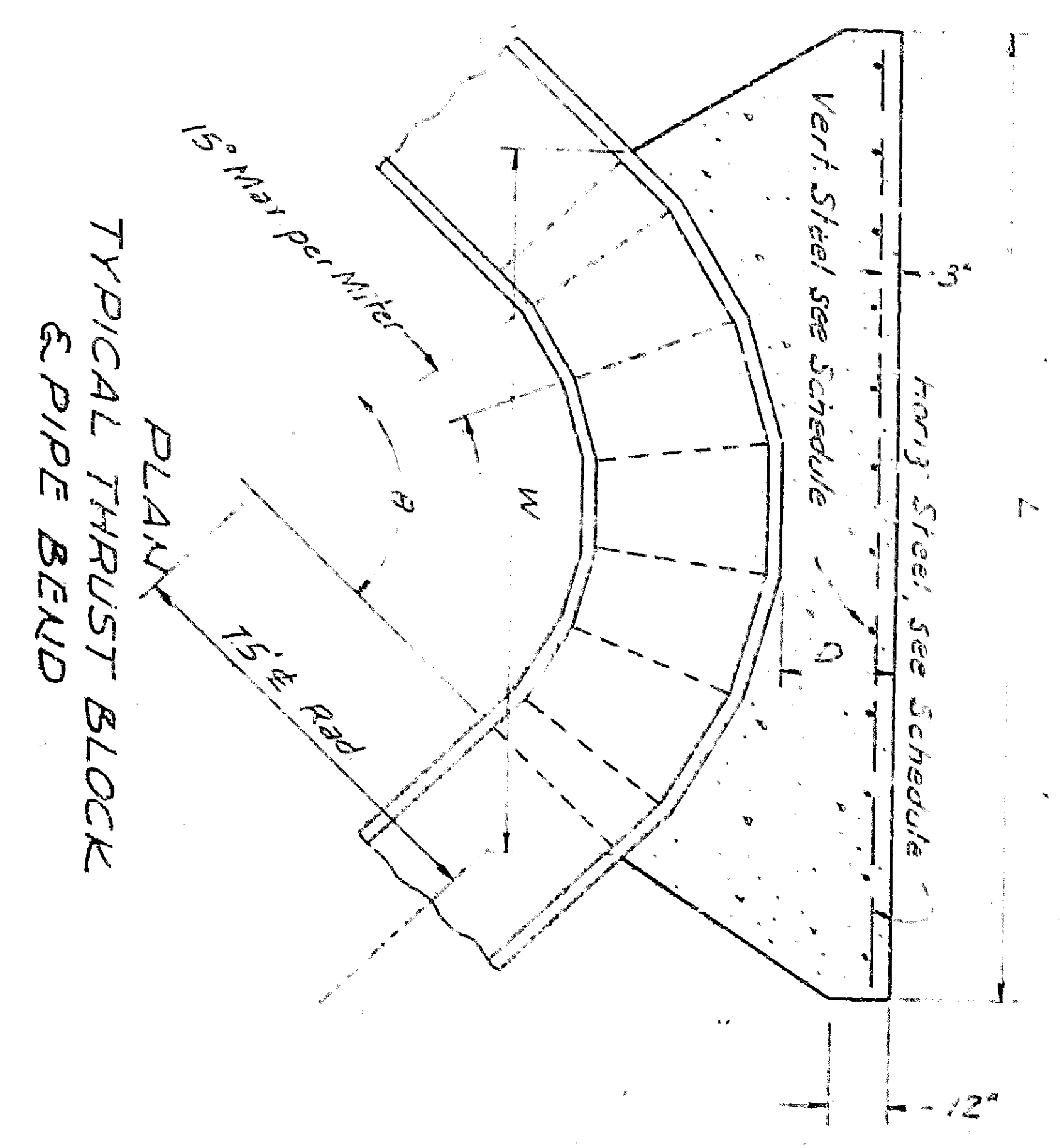

TYPICAL THRUST BLOCK  
Scale: 1/8" = 1'-0"

THRUST BLOCK SCHEDULE

NO.	STATION	D	L	T	U	V	W	HORIZ. STEEL (VERT. STEEL)
1	2+10	3.5'	7.0'	3.0'	-	-	2.0'	4 # 4 @ 20" C
2	6+40	3.0'	11.0'	-	5.0'	-	5.4'	4 # 4 @ 20" C
3	10+30	3.0'	7.0'	-	4.0'	-	3.0'	4 # 4 @ 20" C
4	11+35.6	3.0'	8.5'	-	4.0'	-	3.4'	4 # 4 @ 20" C
5	14+03.6	2.0'	3.5'	-	2.5'	-	0.6'	2 # 4 @ 12" C
6	21+33.4 & 21+75.4	3.0'	12.0'	-	5.0'	-	6.4'	4 # 4 @ 20" C
7	23+84.4 & 24+83	3.5'	16.5'	-	4.0'	-	6.5'	4 # 4 @ 20" C
8	27+40	2.0'	2.0'	-	1.27'	-	1.1'	1 # 4 @ 5' @ 4 # 3 @ 20" C
9	32+80	2.0'	16.0'	-	5.0'	-	7.4'	4 # 4 @ 20" C
10	42+31.2	2.0'	16.0'	-	4.0'	-	10.1'	5 # 4 @ 12" C
11	48+44.2	1.0'	2.5'	-	2.5'	-	1.0'	2 # 4 @ 12" C
12	48+44.2	1.0'	4.0'	-	3.0'	-	2.4'	3 # 4 @ 12" C
13	48+44.2	1.0'	4.0'	-	2.5'	-	2.4'	3 # 4 @ 12" C
14	48+44.2	1.0'	4.0'	-	2.5'	-	2.5'	3 # 4 @ 12" C
15	48+44.2	1.0'	4.0'	-	2.5'	-	2.5'	3 # 4 @ 12" C
16	48+44.2	1.0'	4.0'	-	2.5'	-	2.5'	3 # 4 @ 12" C
17	48+44.2	1.0'	4.0'	-	2.5'	-	2.5'	3 # 4 @ 12" C
18	48+44.2	1.0'	4.0'	-	2.5'	-	2.5'	3 # 4 @ 12" C
19	48+44.2	1.0'	4.0'	-	2.5'	-	2.5'	3 # 4 @ 12" C
20	48+44.2	1.0'	4.0'	-	2.5'	-	2.5'	3 # 4 @ 12" C

NOTE: All thrusting between thrust blocks and undisturbed ground is to be made with clean sand. Minimum compaction to be 95% by 15.19" O. 200 Method. Vertical in Compaction to be 300' psi. 20-75'.

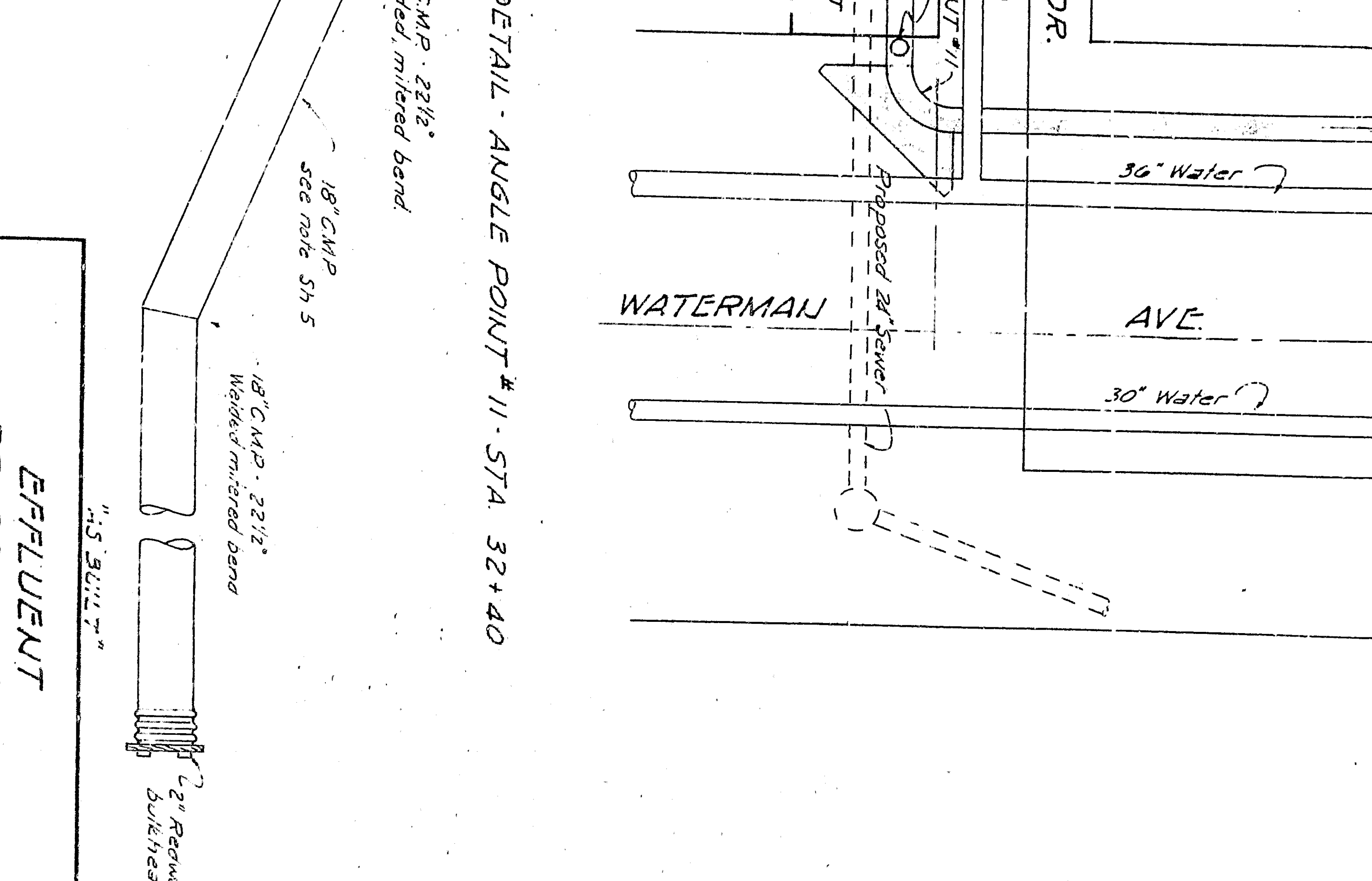
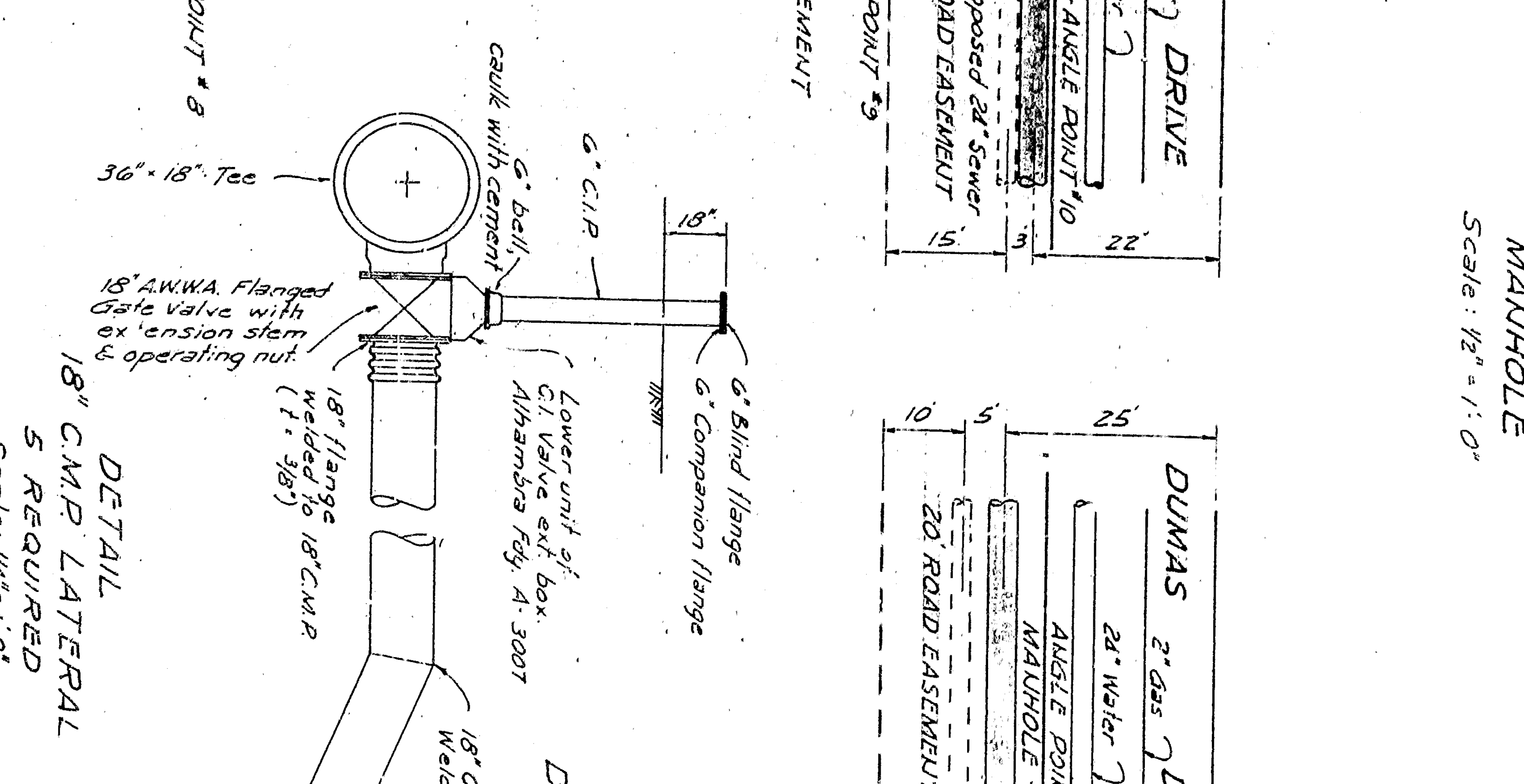
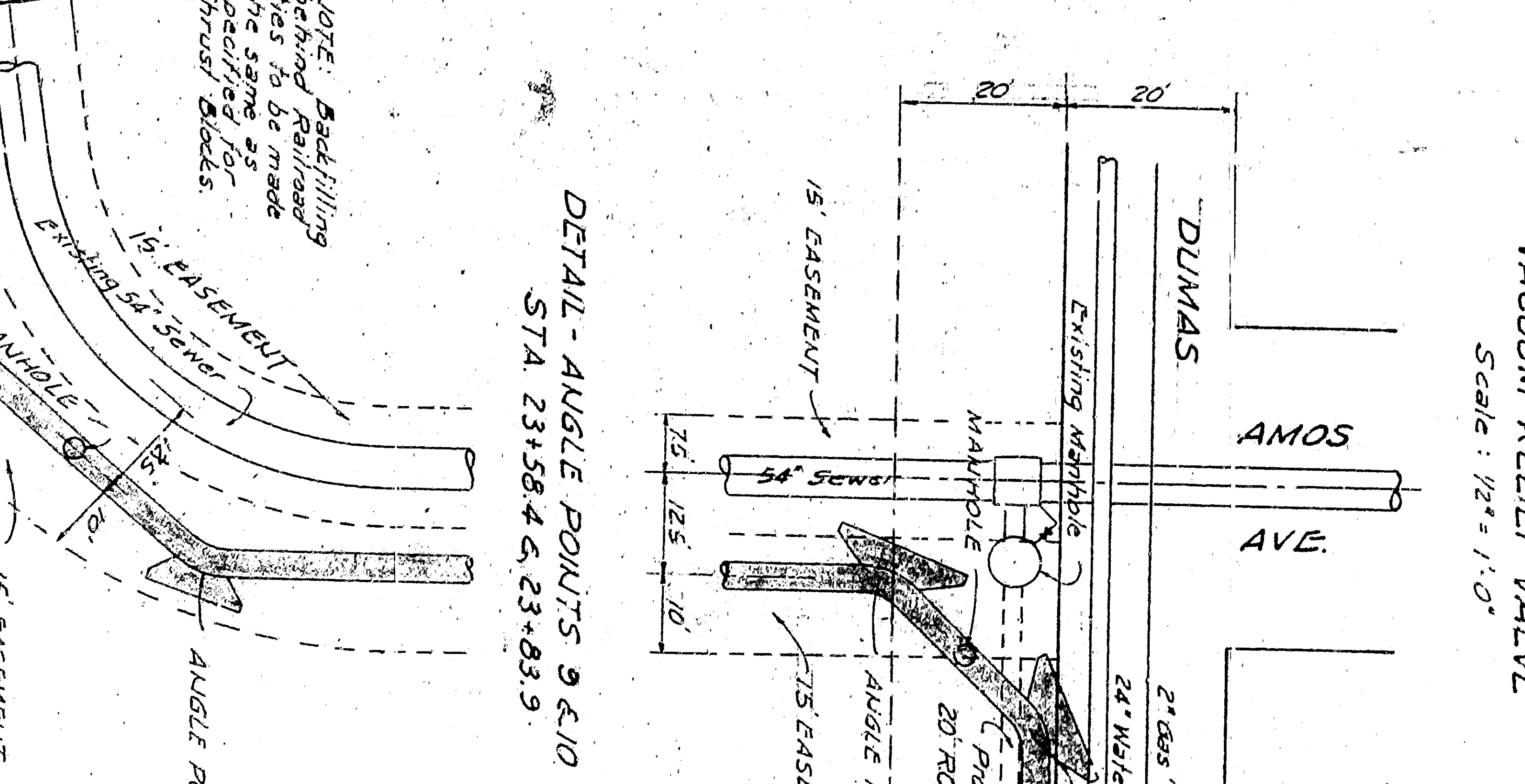
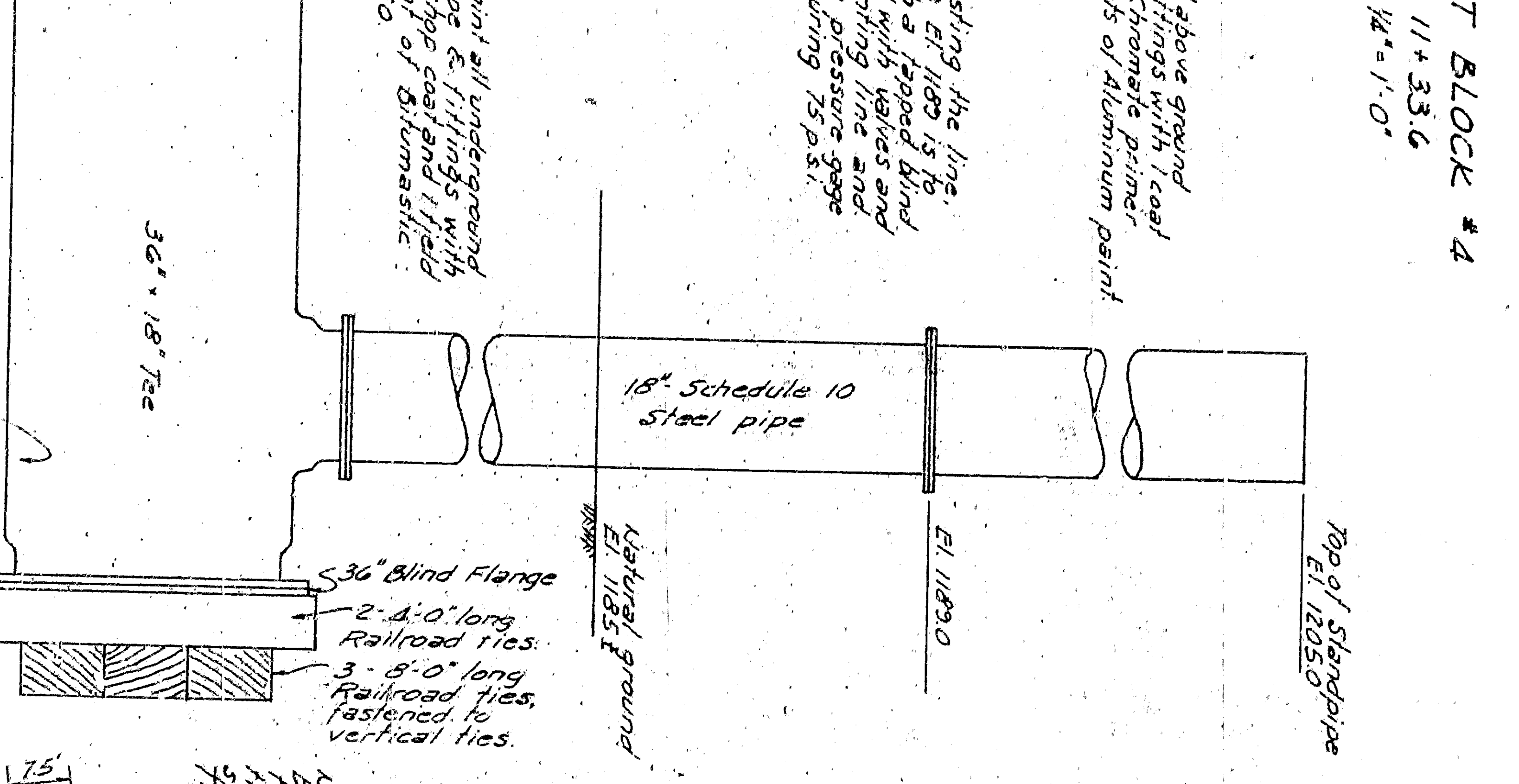
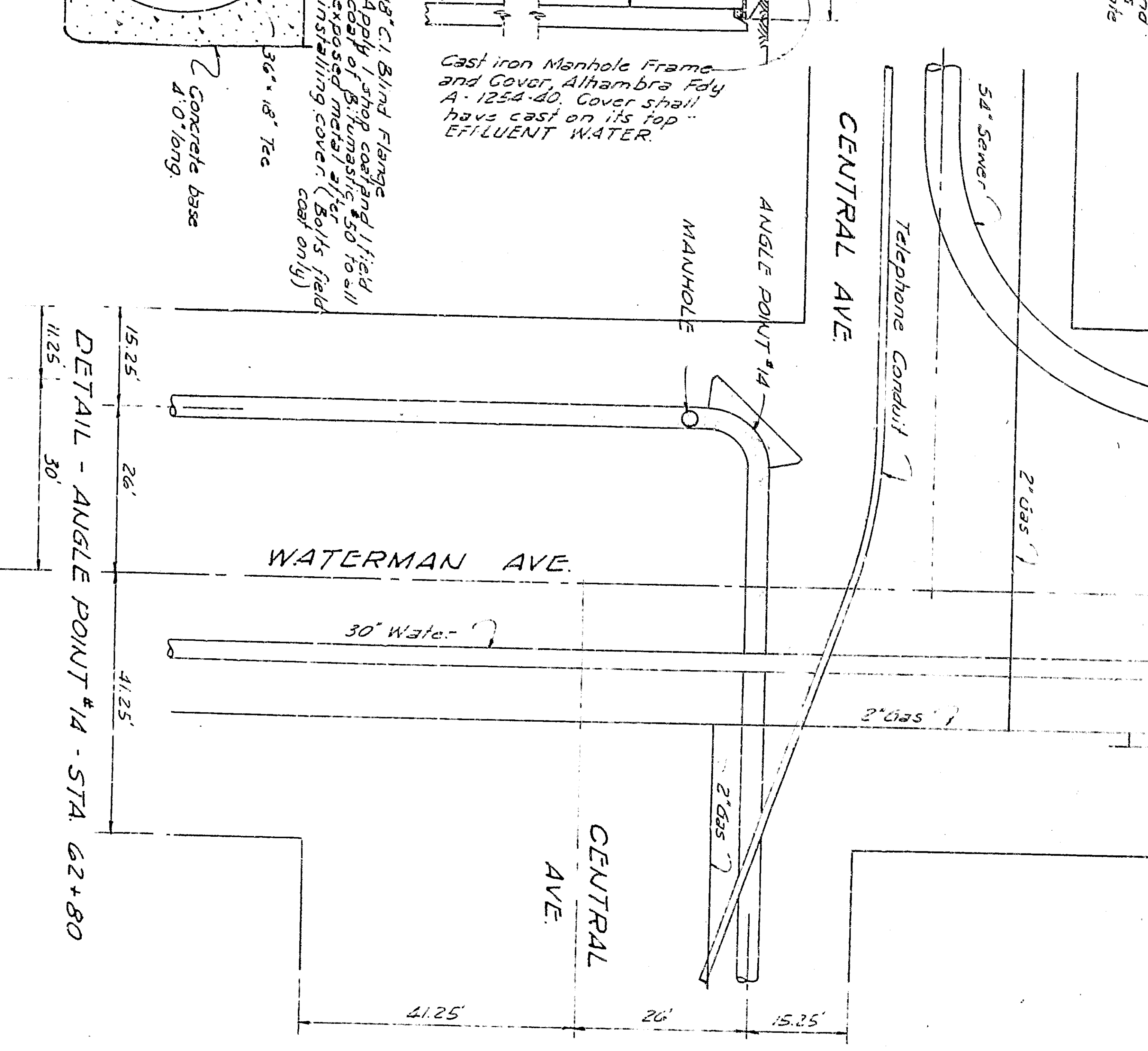
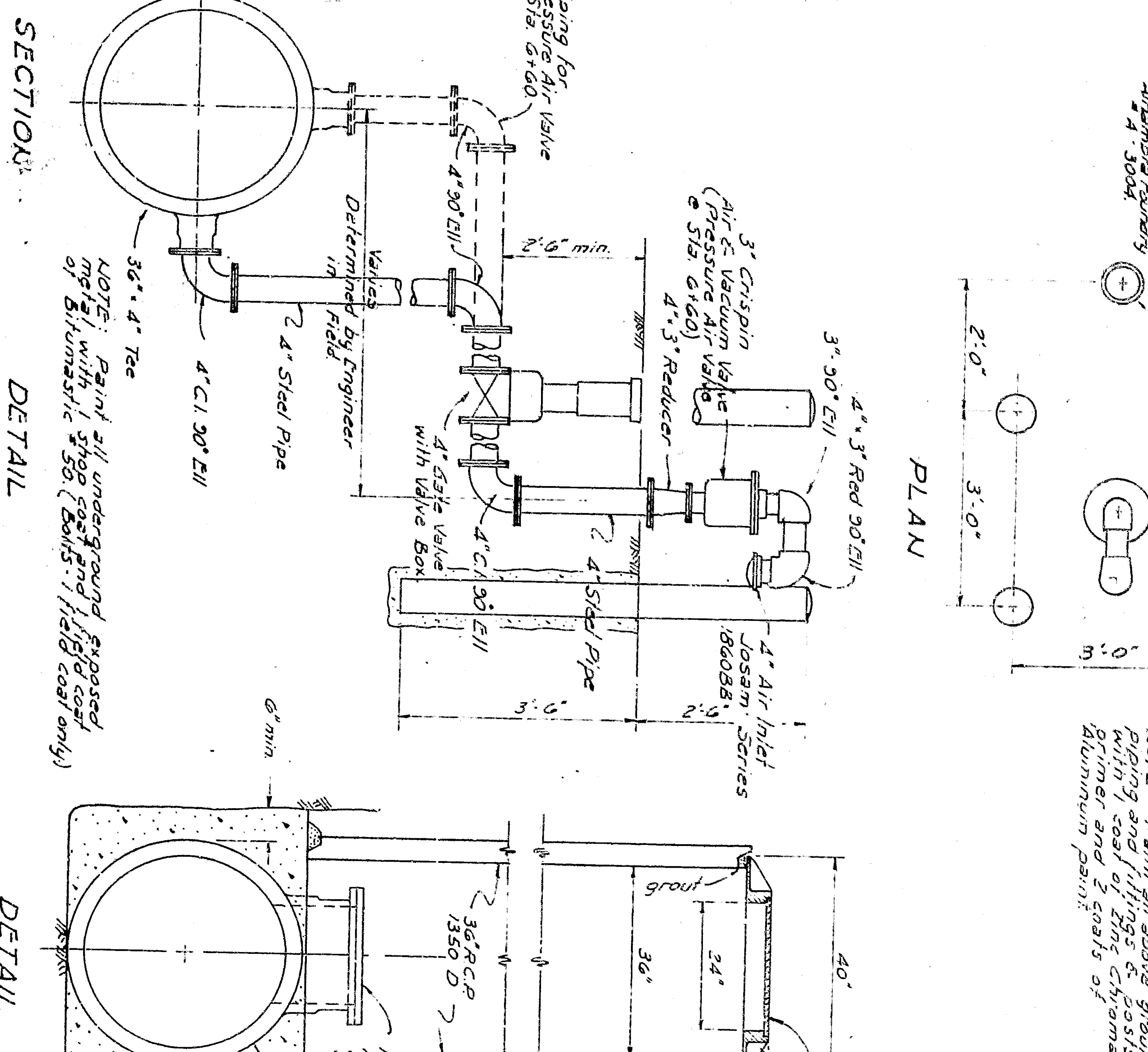
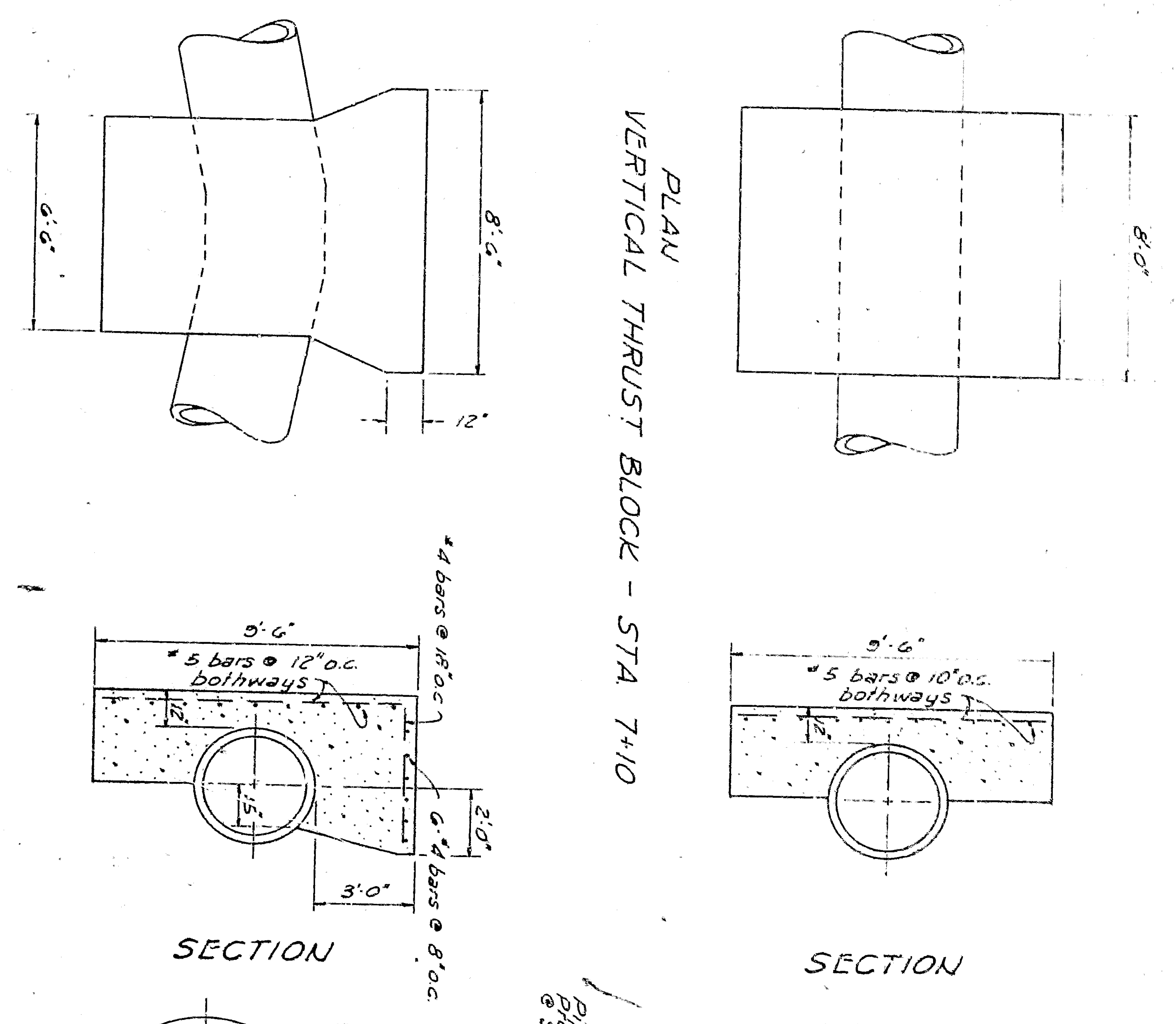

EFFLUENT PRESSURE LINE  
SAU BERRIARQUIO  
CALIFORNIA  
1960  
CURRIE ENGINEERING COMPANY  
CONSULTING ENGINEERS